

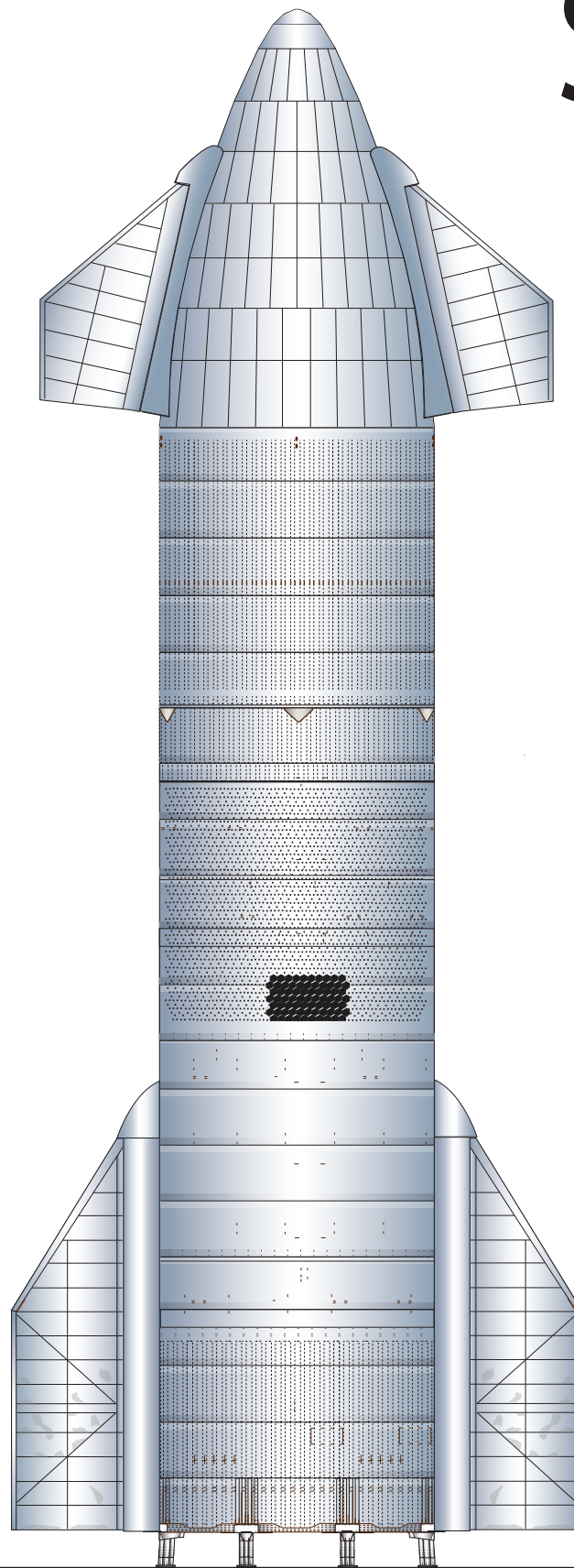

1:100 Scale

SN-9



S
T
A
R
S
H
I
P

Designed by Alfonso X Moreno
©2021 Not for commercial use



SpaceX Starship SN9

Print on Cardstock (110 lbs)

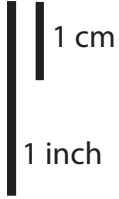

1:100 Scale

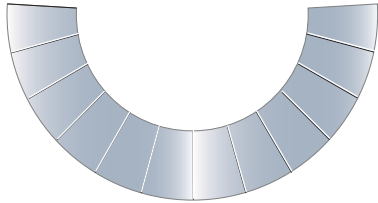

ring 7

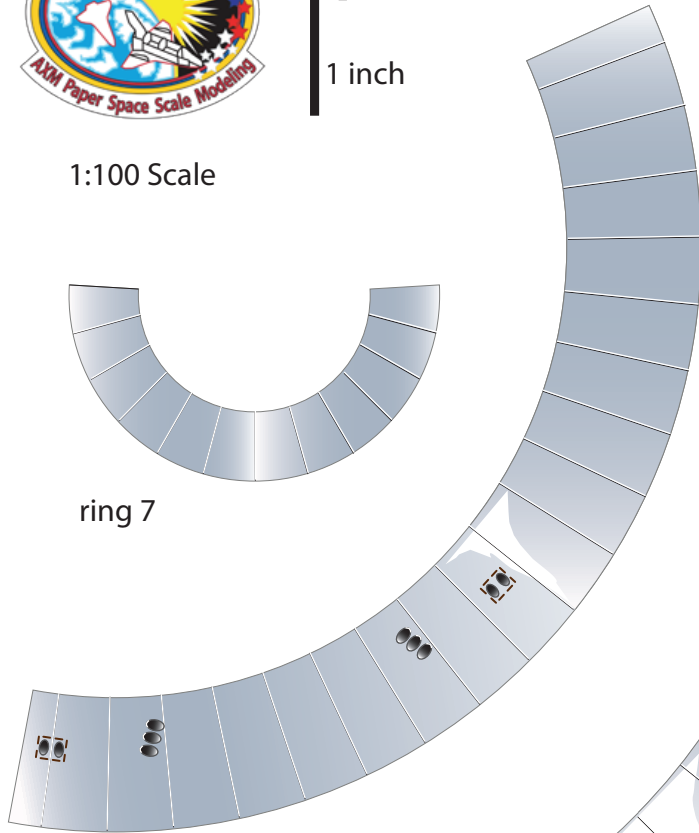

ring 5

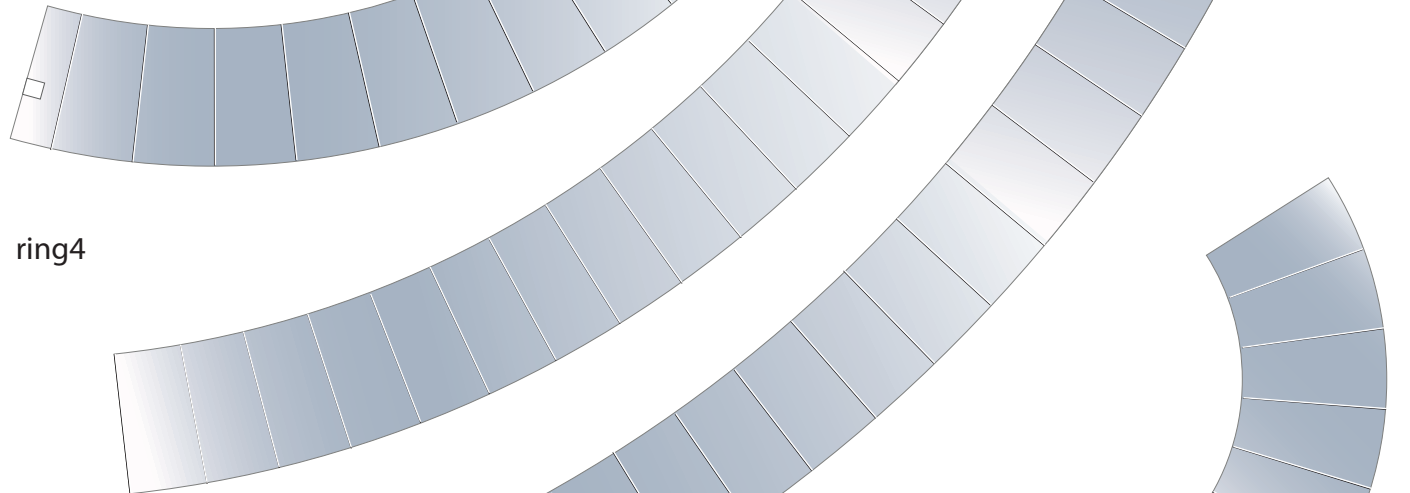

ring 4

ring 3

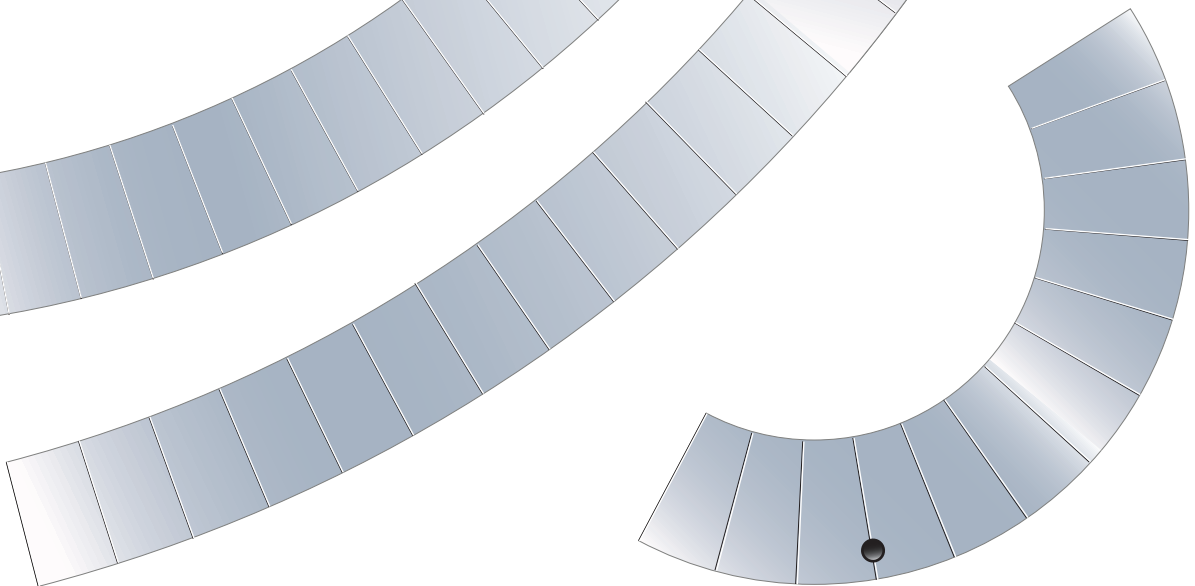

ring 2



ring 9



ring 8

ring 6

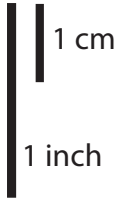

SpaceX Starship SN9

Print on Cardstock (110 lbs)

1:100 Scale

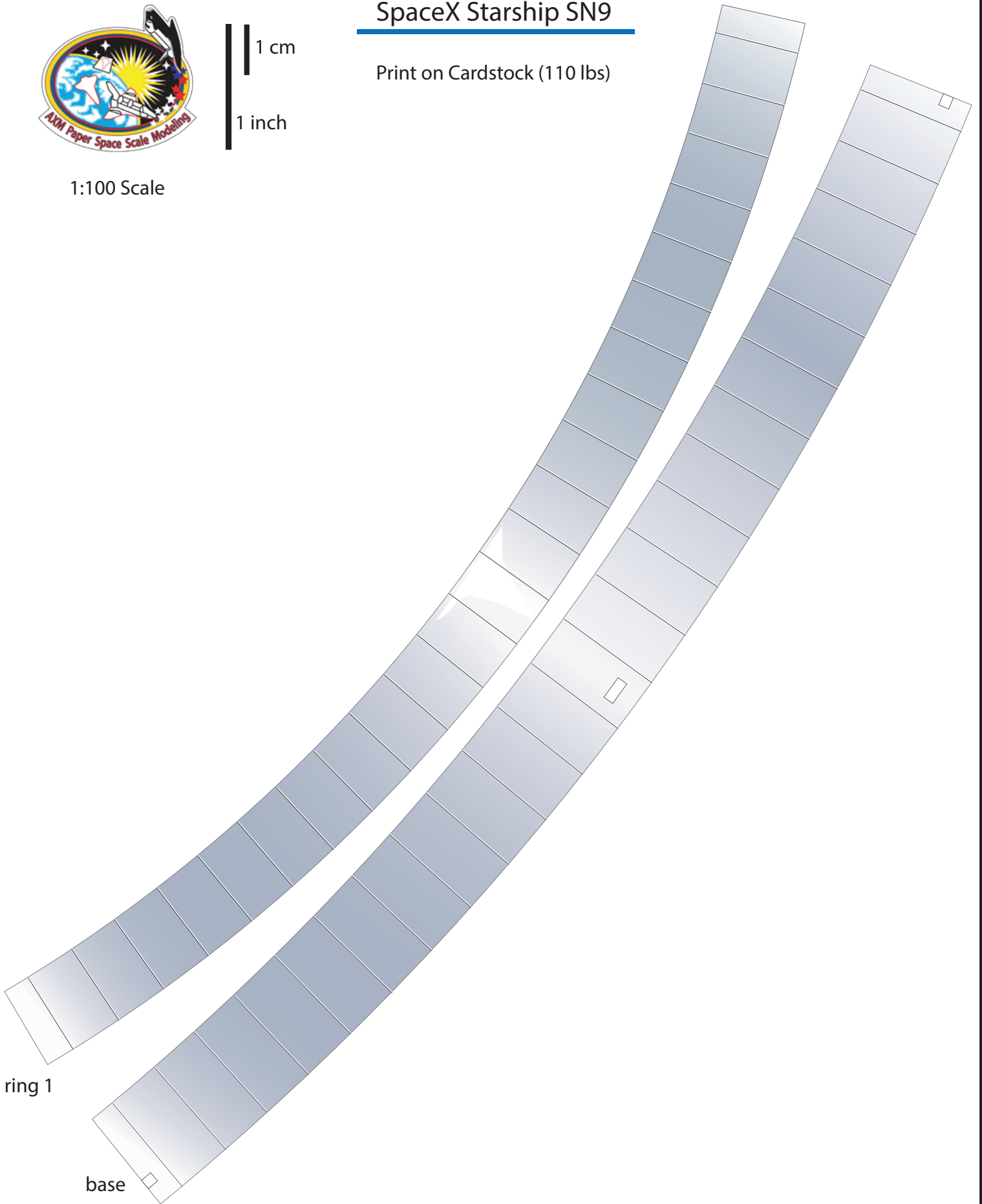

ring 1

base



1:100 Scale

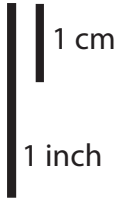

SpaceX Starship SN9

Print on Cardstock (110 lbs)

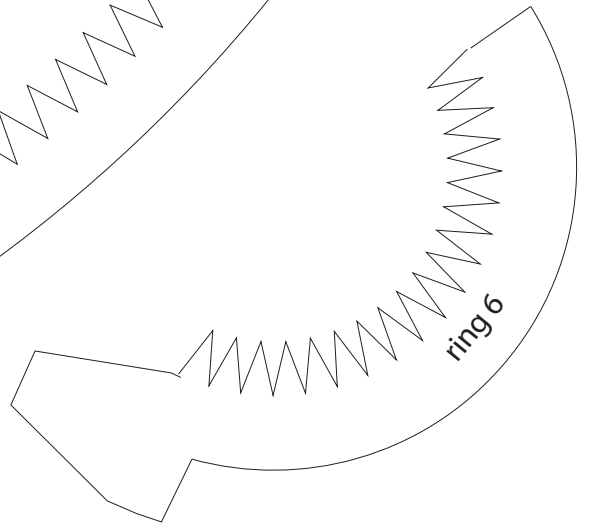
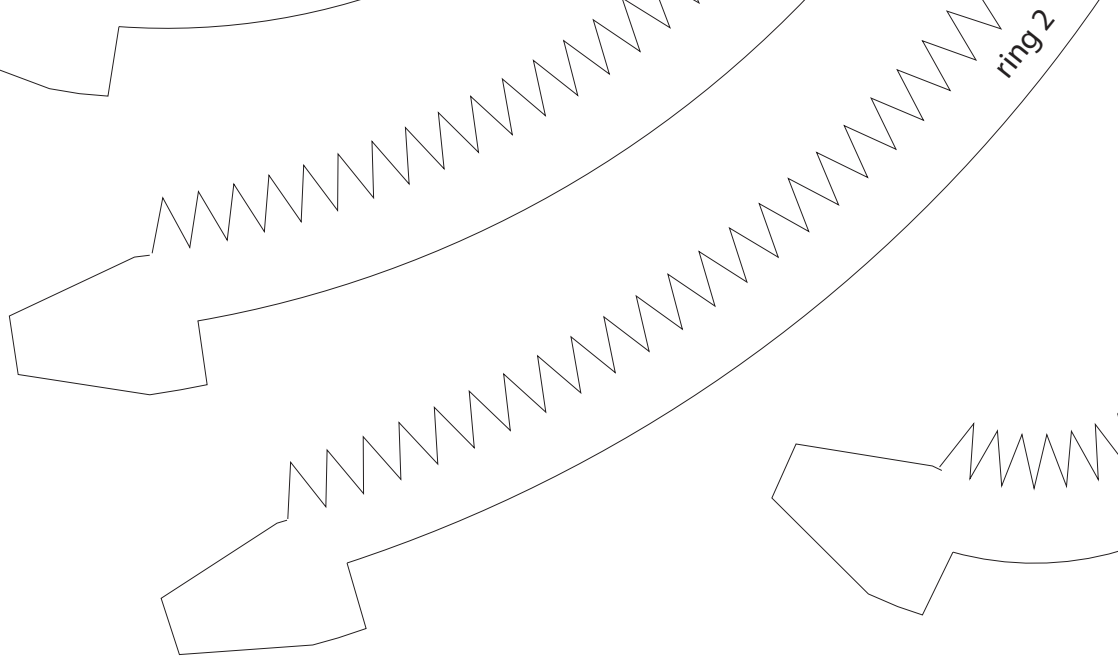
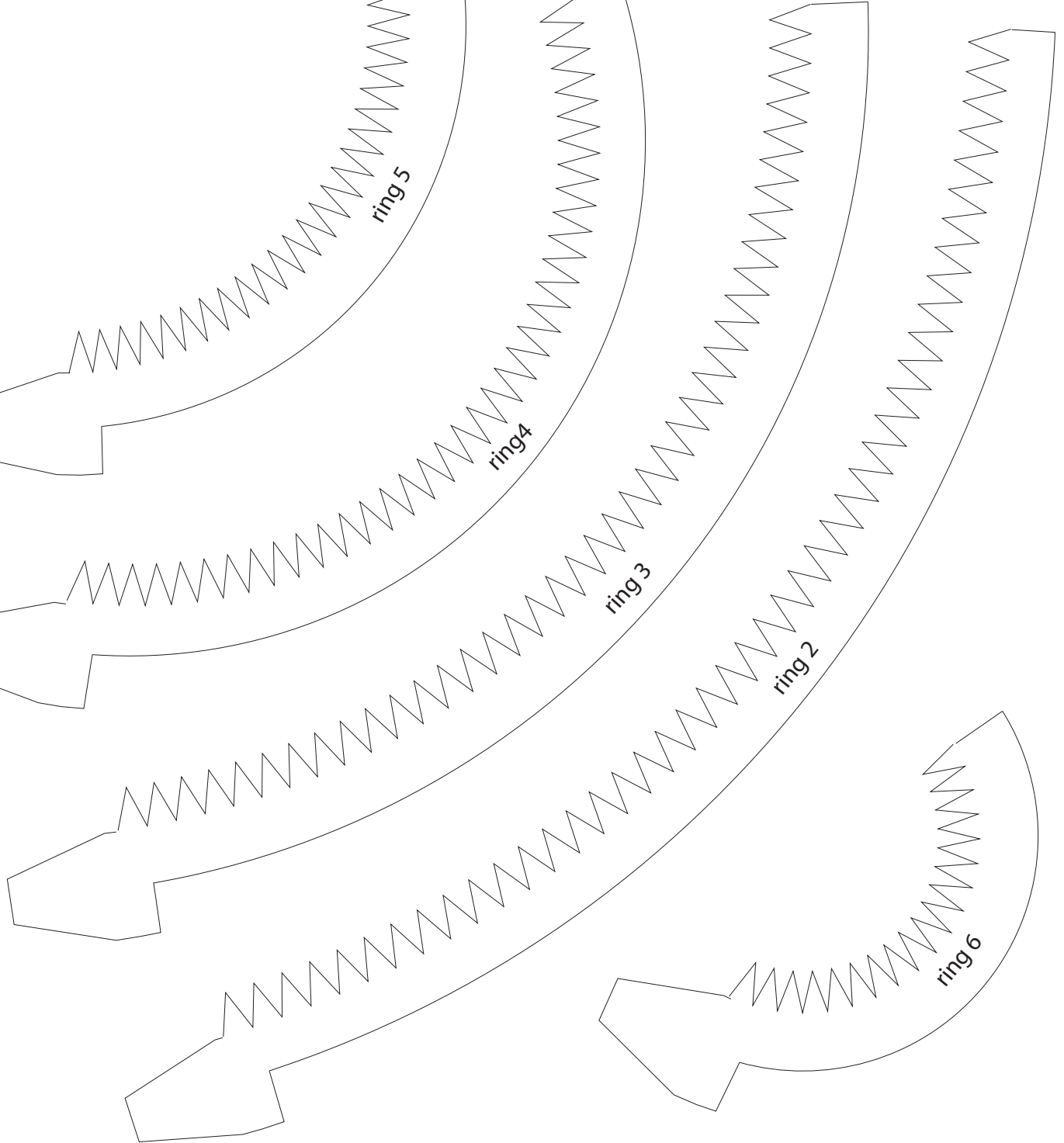
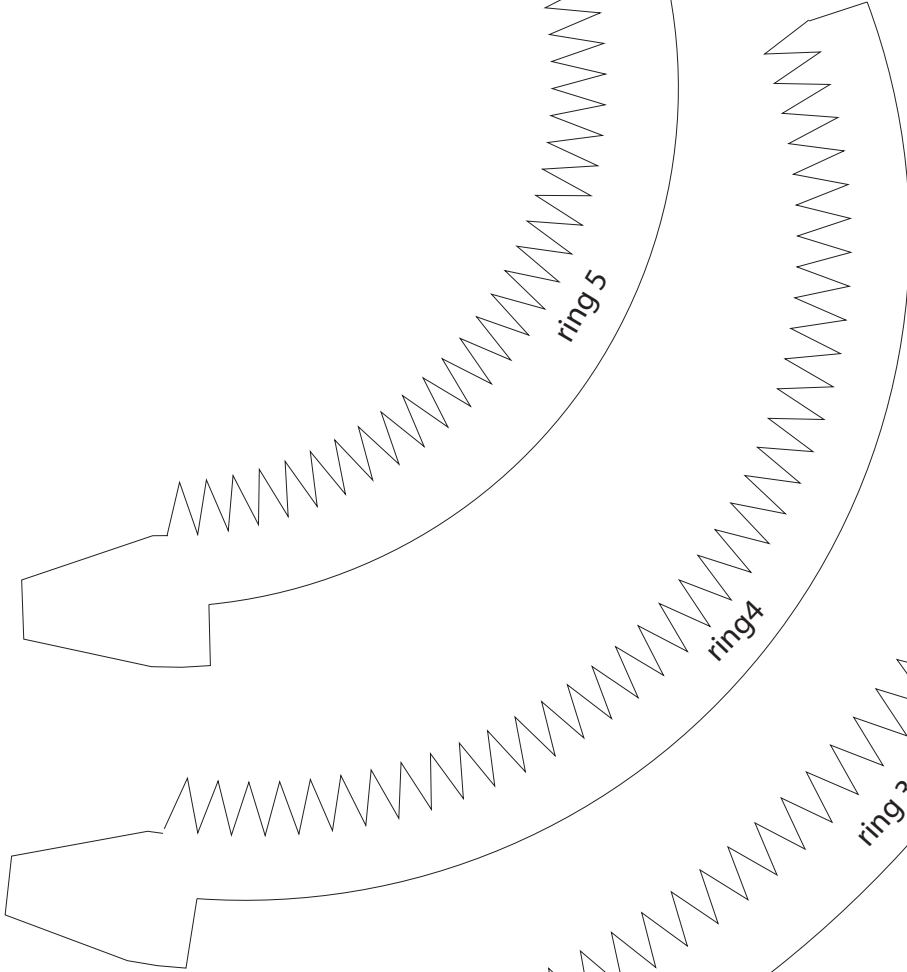
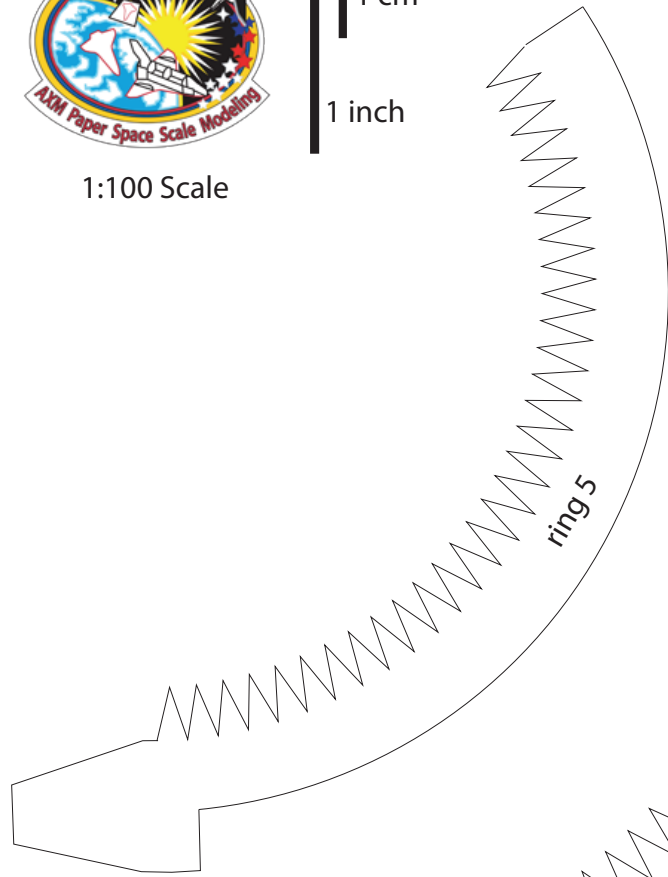
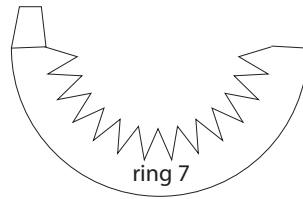



1:100 Scale

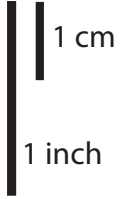

SpaceX Starship SN9

Print on Cardstock (110 lbs)

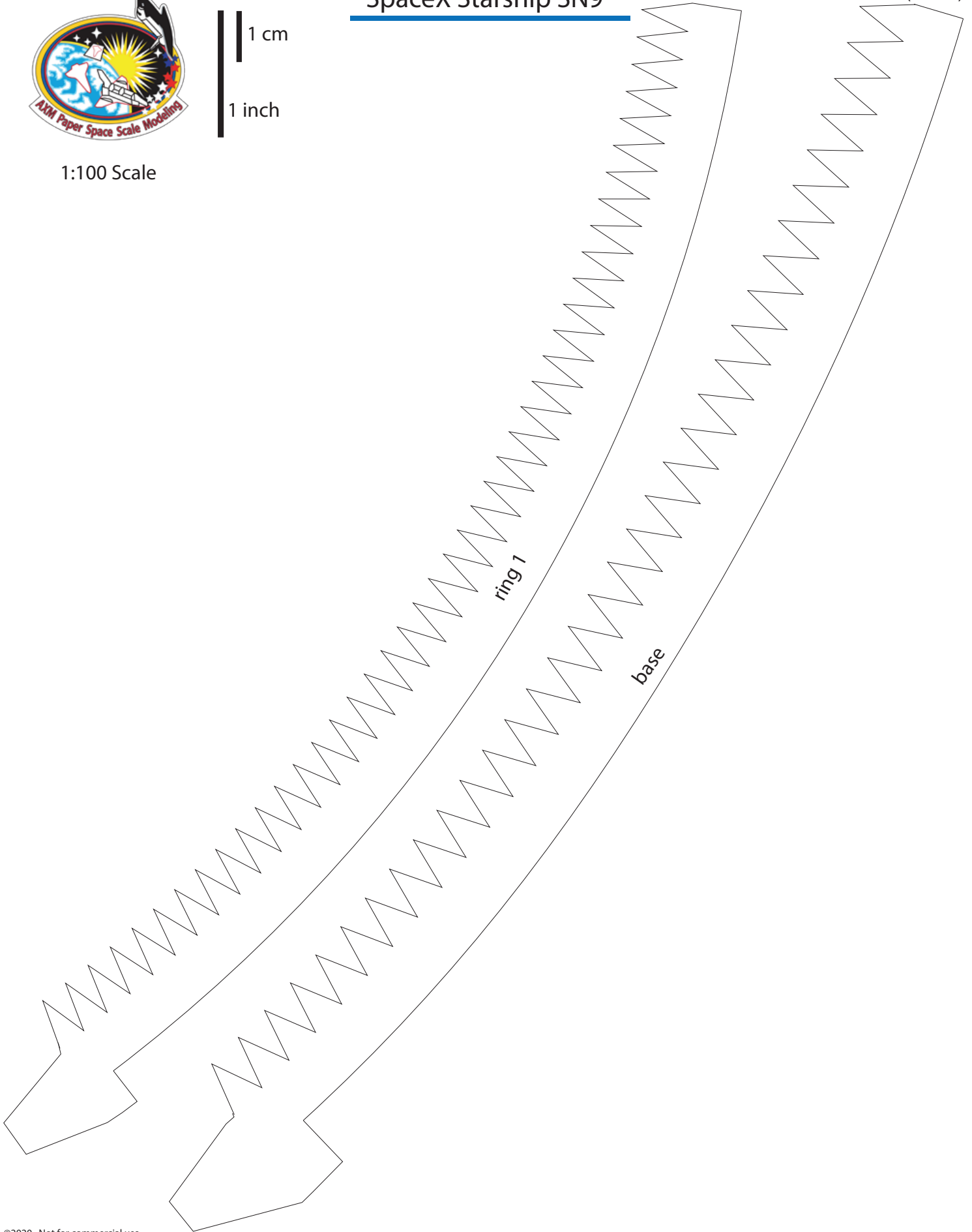



1:100 Scale



SpaceX Starship SN9

Print on Cardstock (110 lbs)

Nosecone-body 5 ring stack

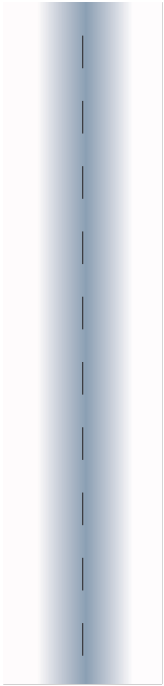

Umbilical side

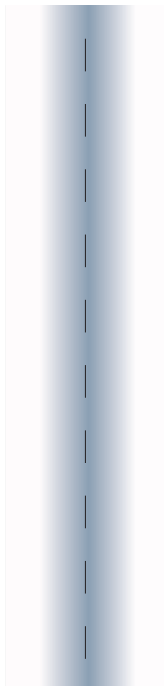
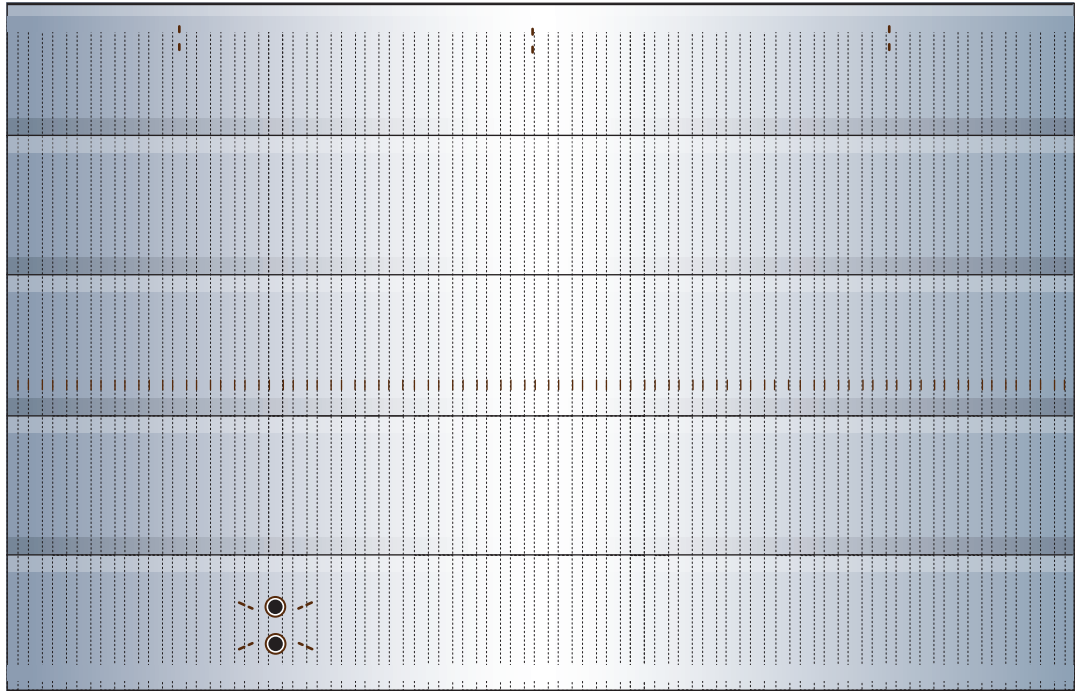

Front

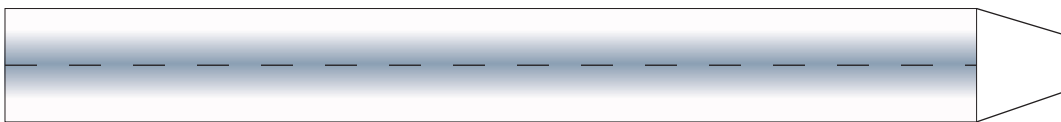
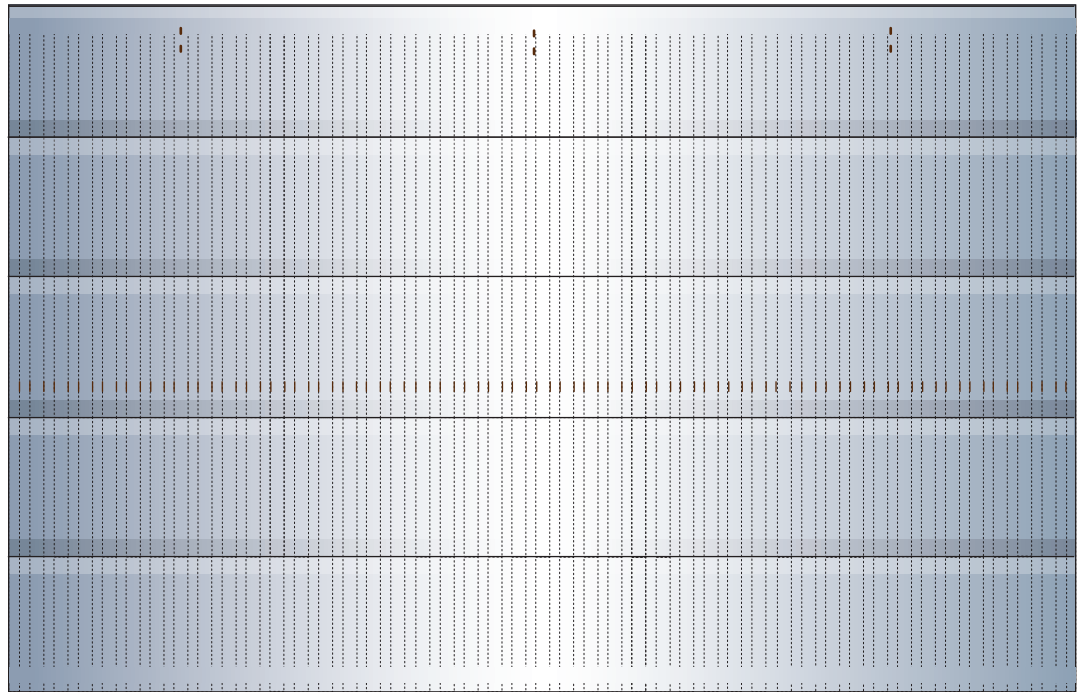

Connectors for 5 ring stack and body

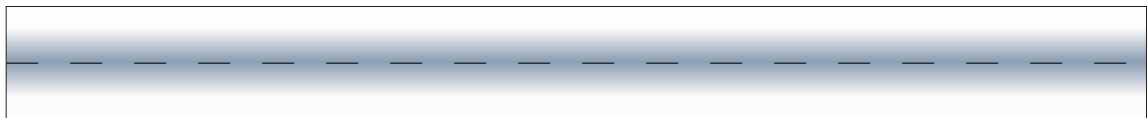



1:100 Scale



SpaceX Starship SN9

Print on Cardstock (110 lbs)

Nosecone-body 5 ring stack interior detail

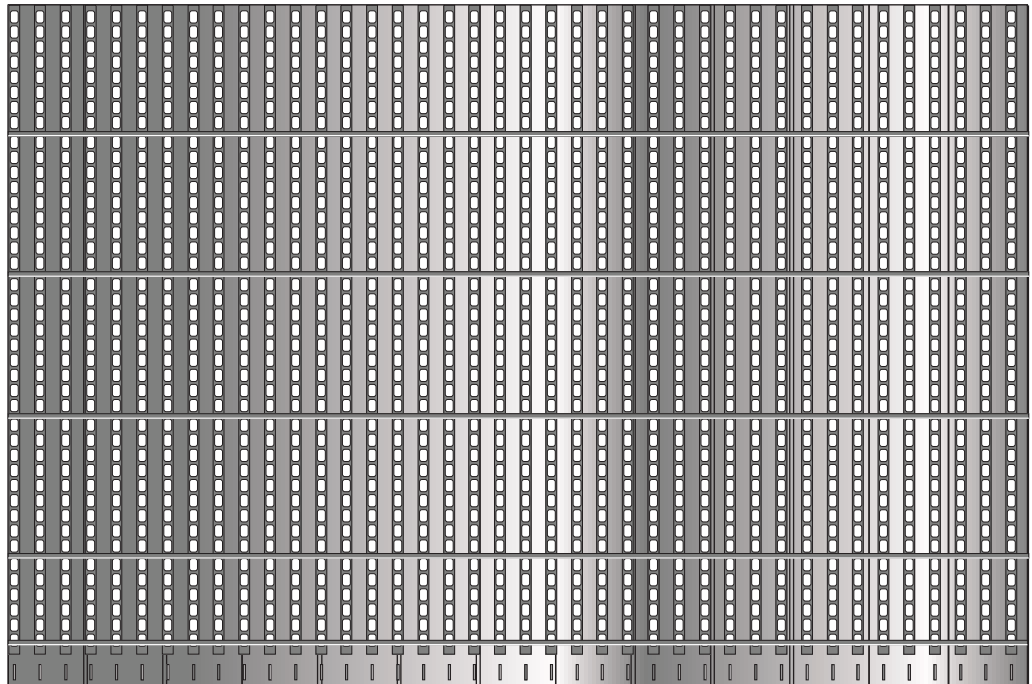
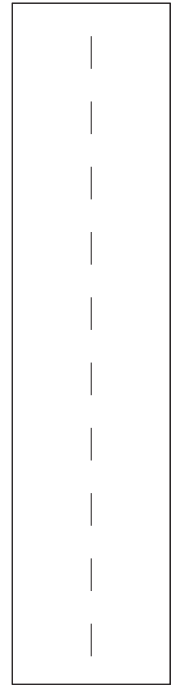
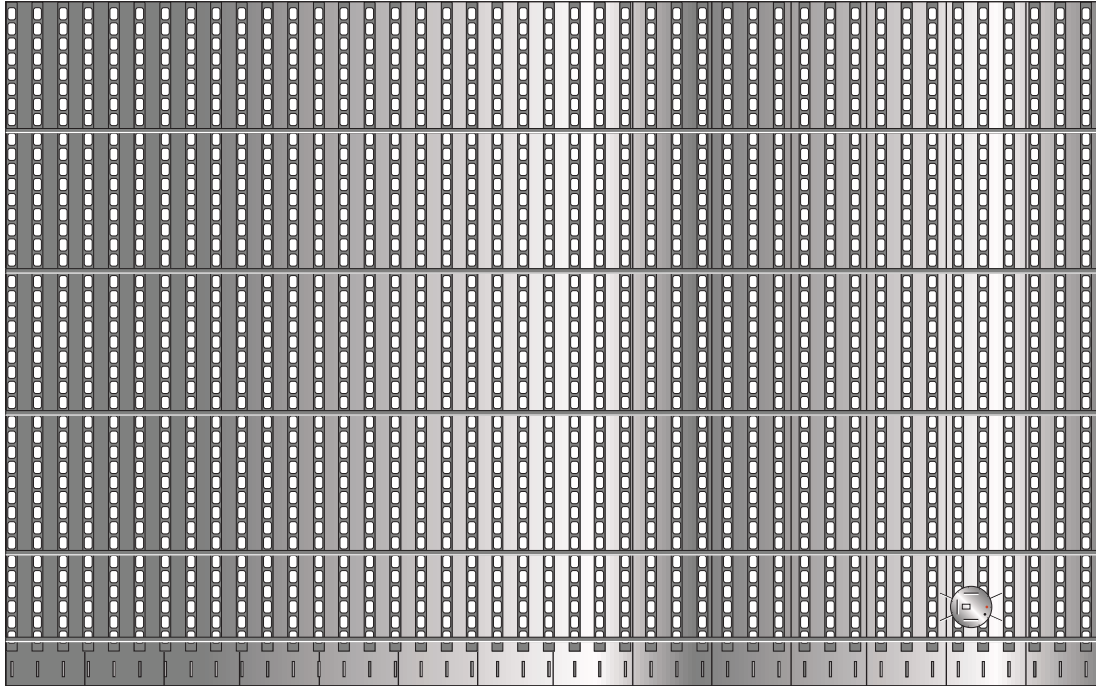



1 cm

1 inch

1:100 Scale

Starship SN Upper Dome

Print on Cardstock (110 lbs)

(Optional)

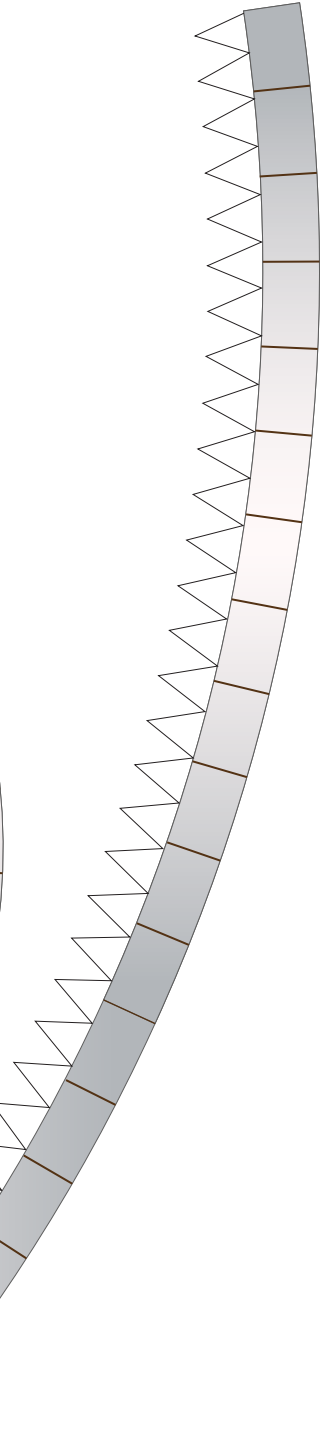
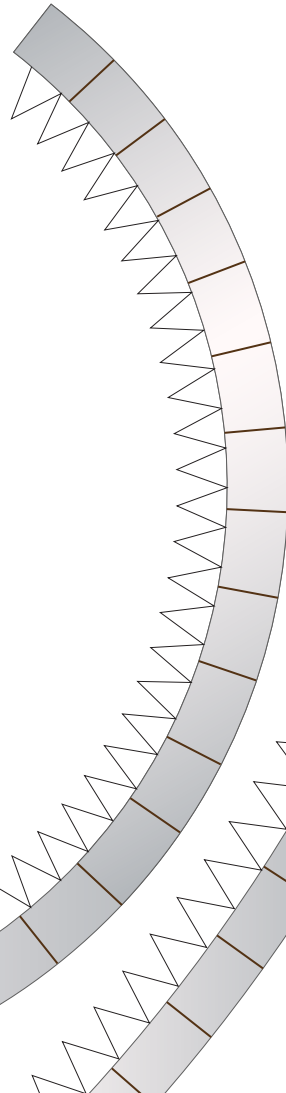
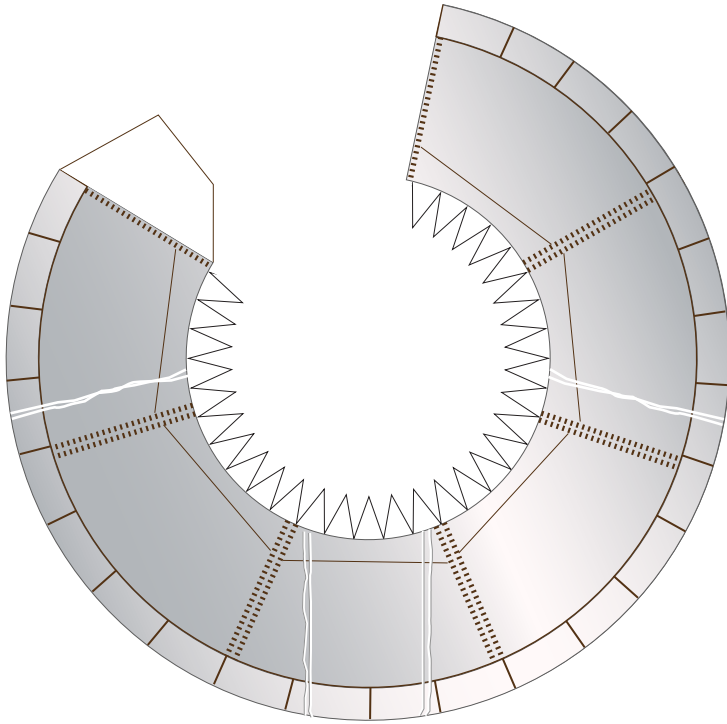
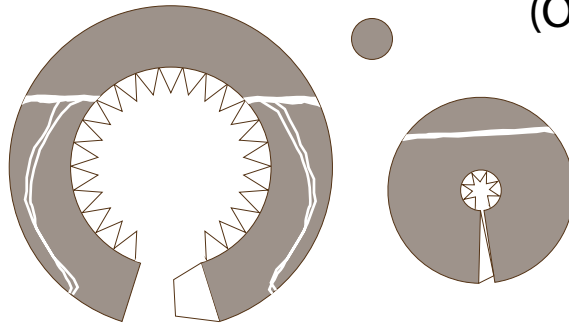

↔
Tesla
Battery

Tesla Battery

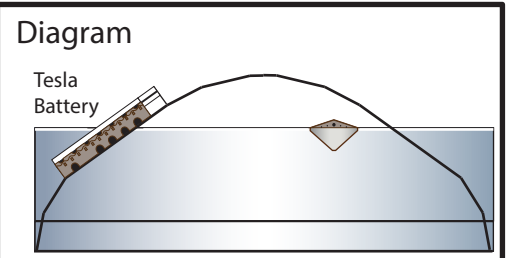
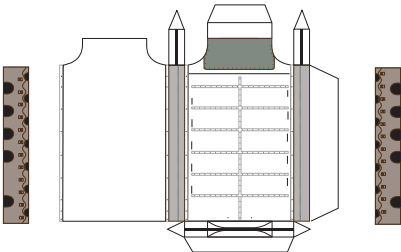



1:100 Scale

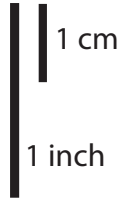

SpaceX Starship SN-9

Former for upper dome

Print on Cardstock (110 lbs)

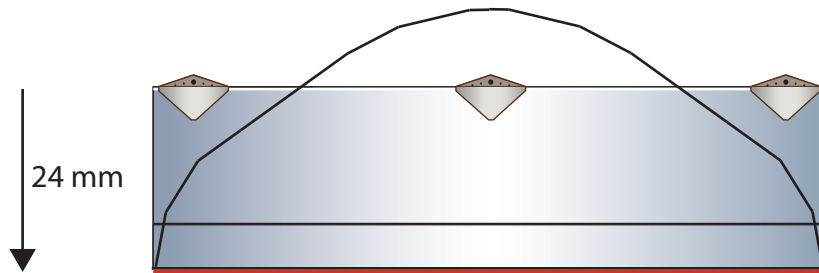
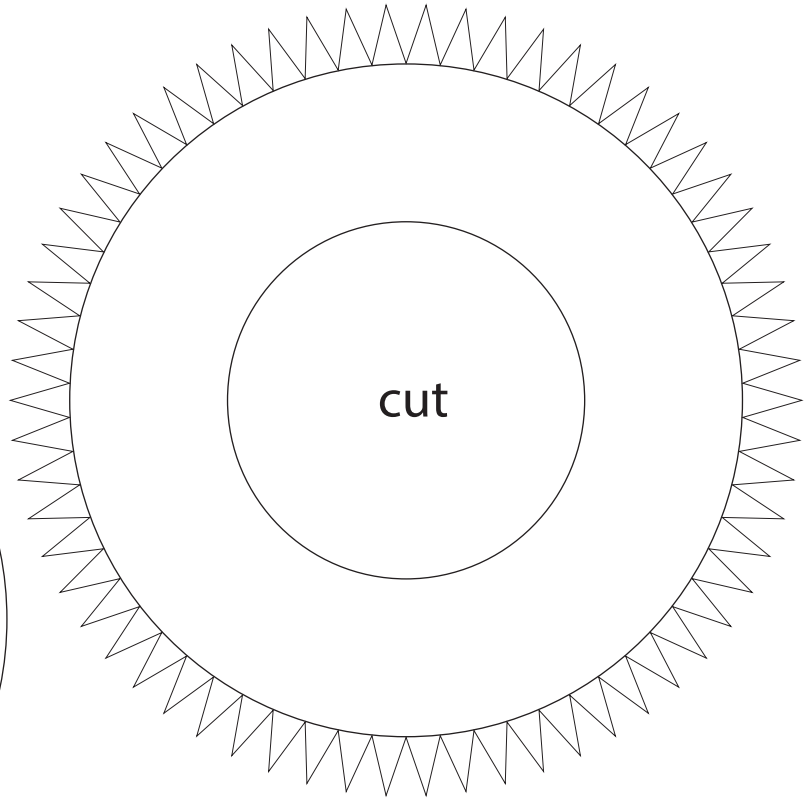
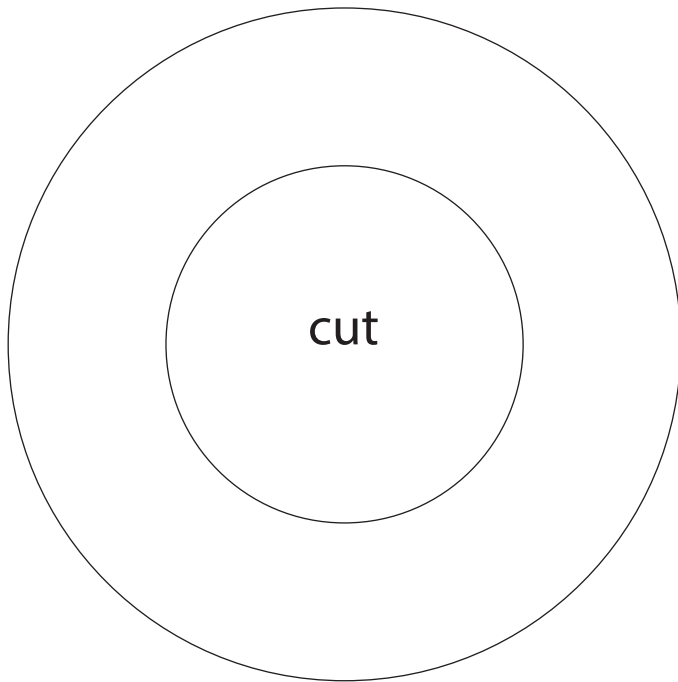

IMPORTANT

Top former is glued 24 mm from top edge of upper body for Starship SN-9 model



1:100 Scale



SpaceX Starship SN9

Print on Cardstock (110 lbs)

REVISED

Belly top

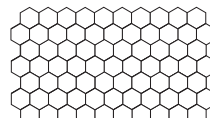
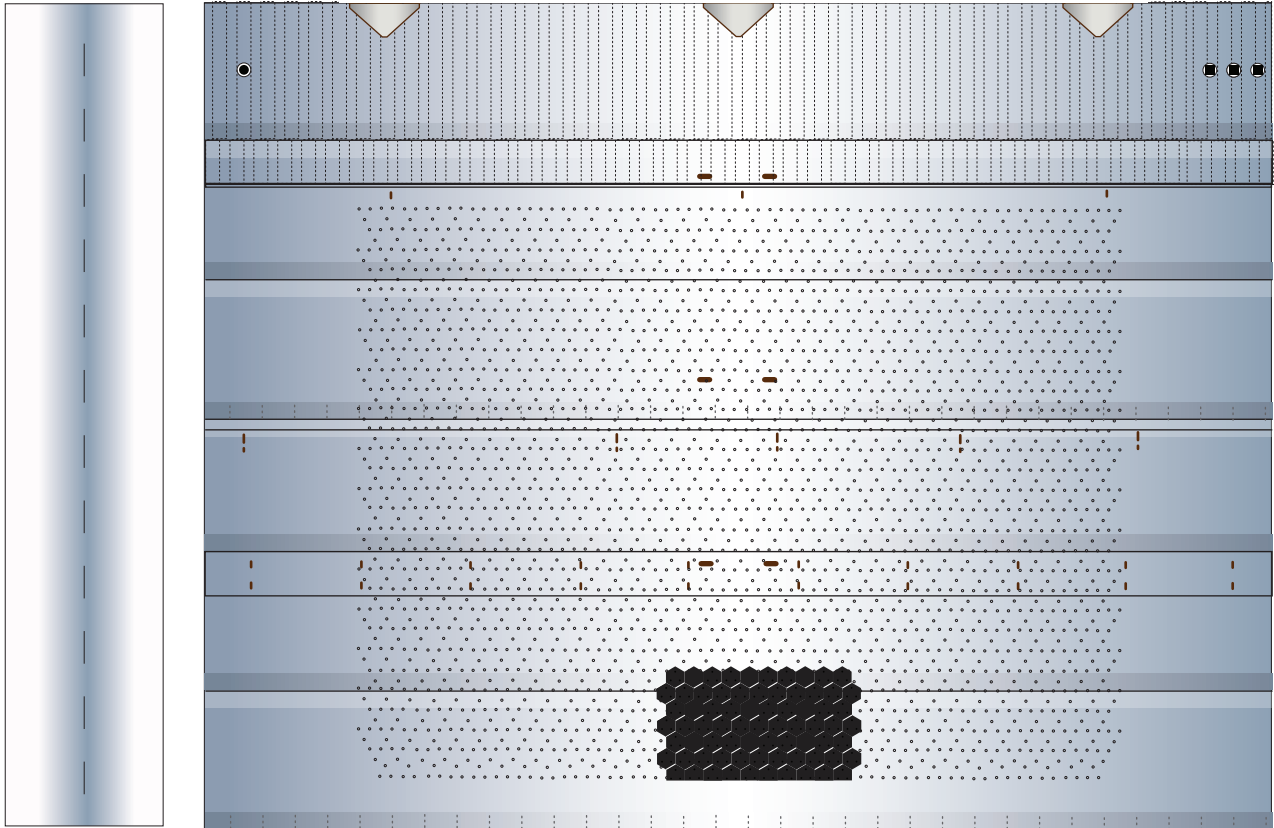
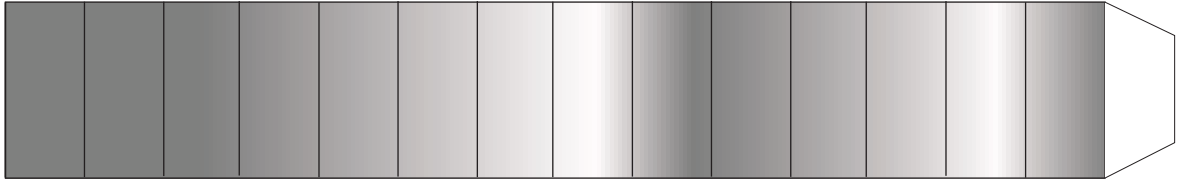



1:100 Scale



SpaceX Starship SN9

Print on Cardstock (110 lbs)

Back top

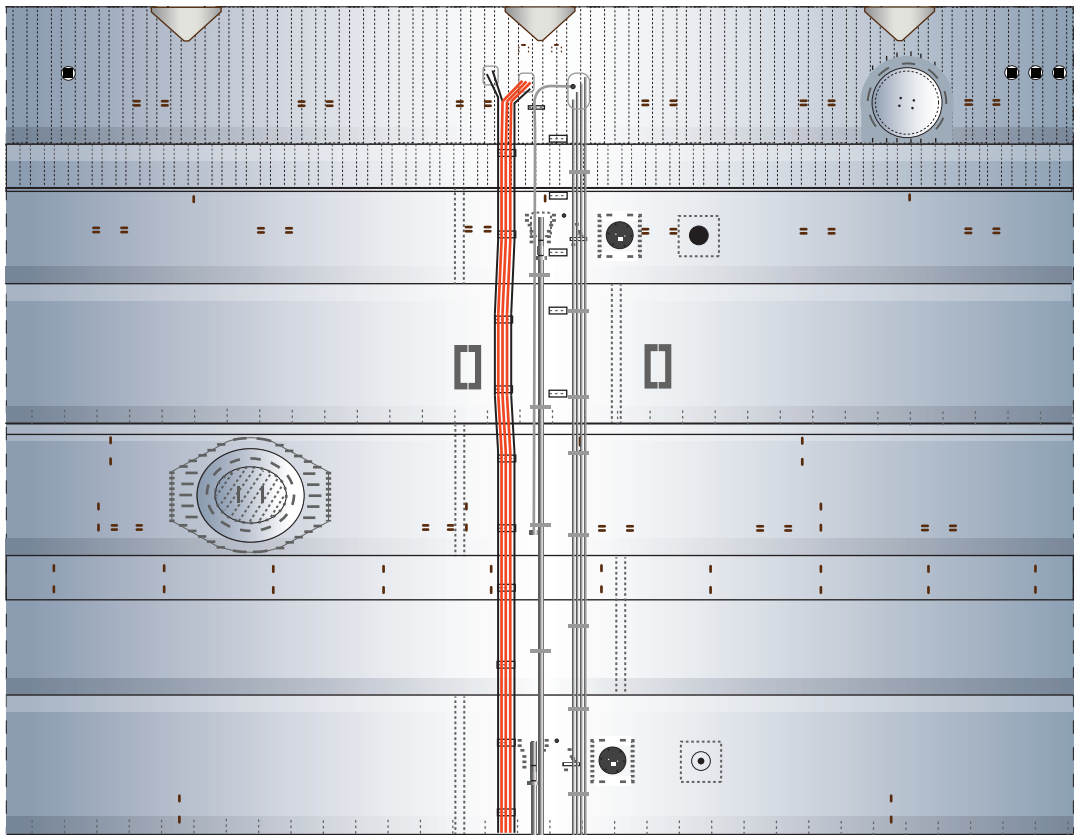
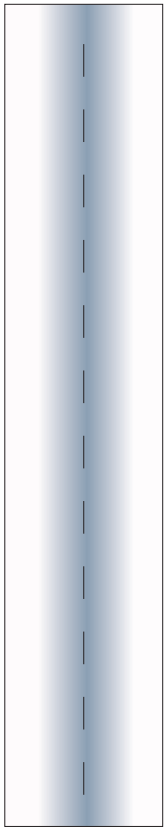
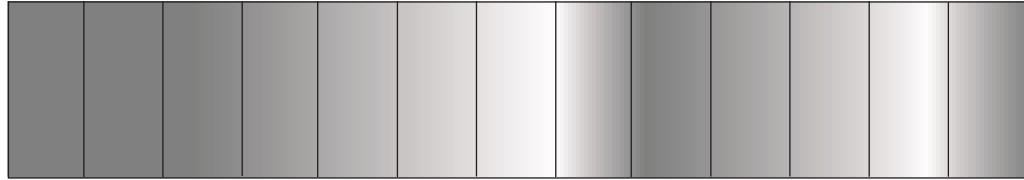



1:100 Scale



SpaceX Starship SN9

Print on Cardstock (110 lbs)

Belly side bottom

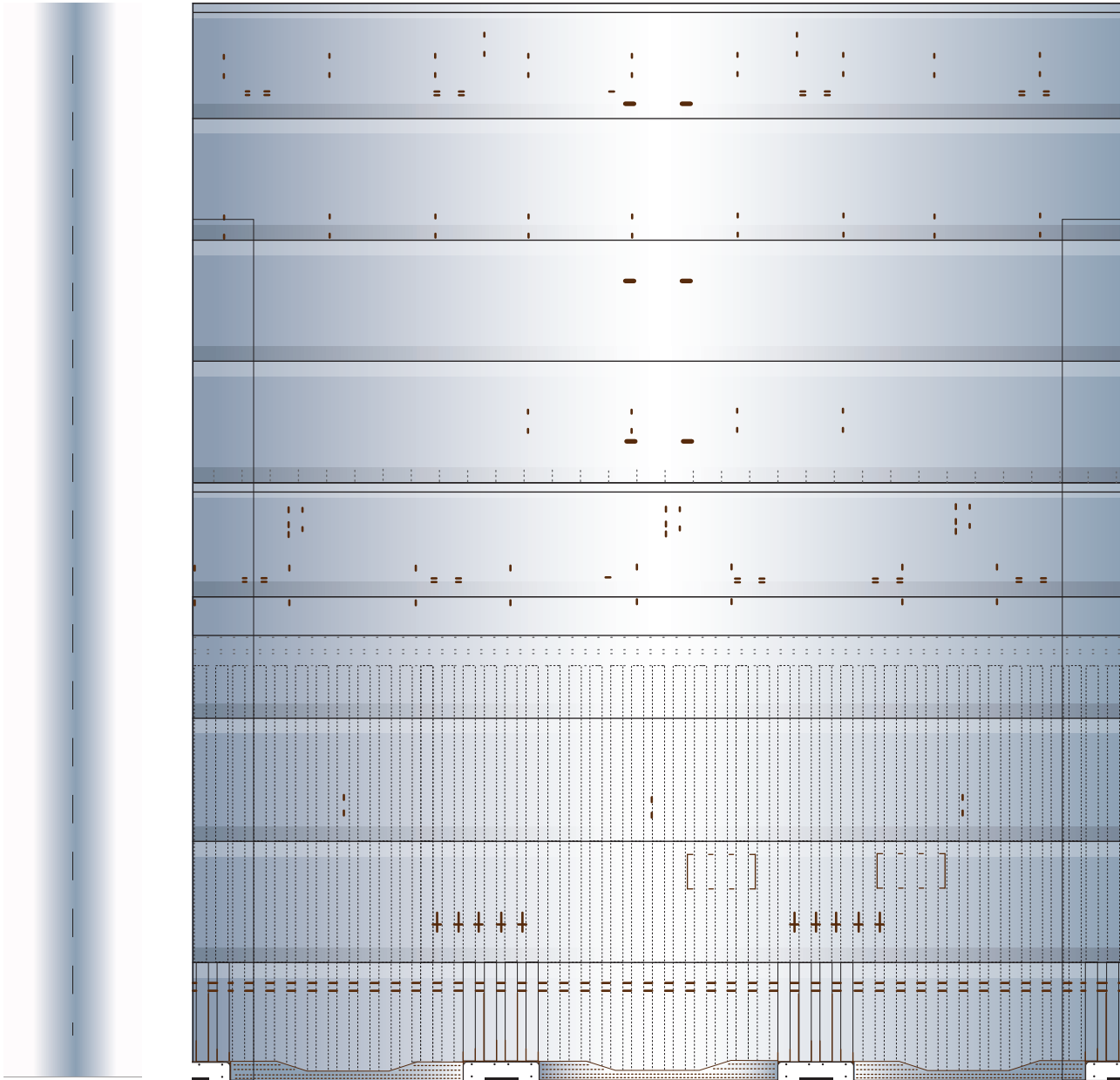



1:100 Scale



SpaceX Starship SN9

Print on Cardstock (110 lbs)

Back bottom

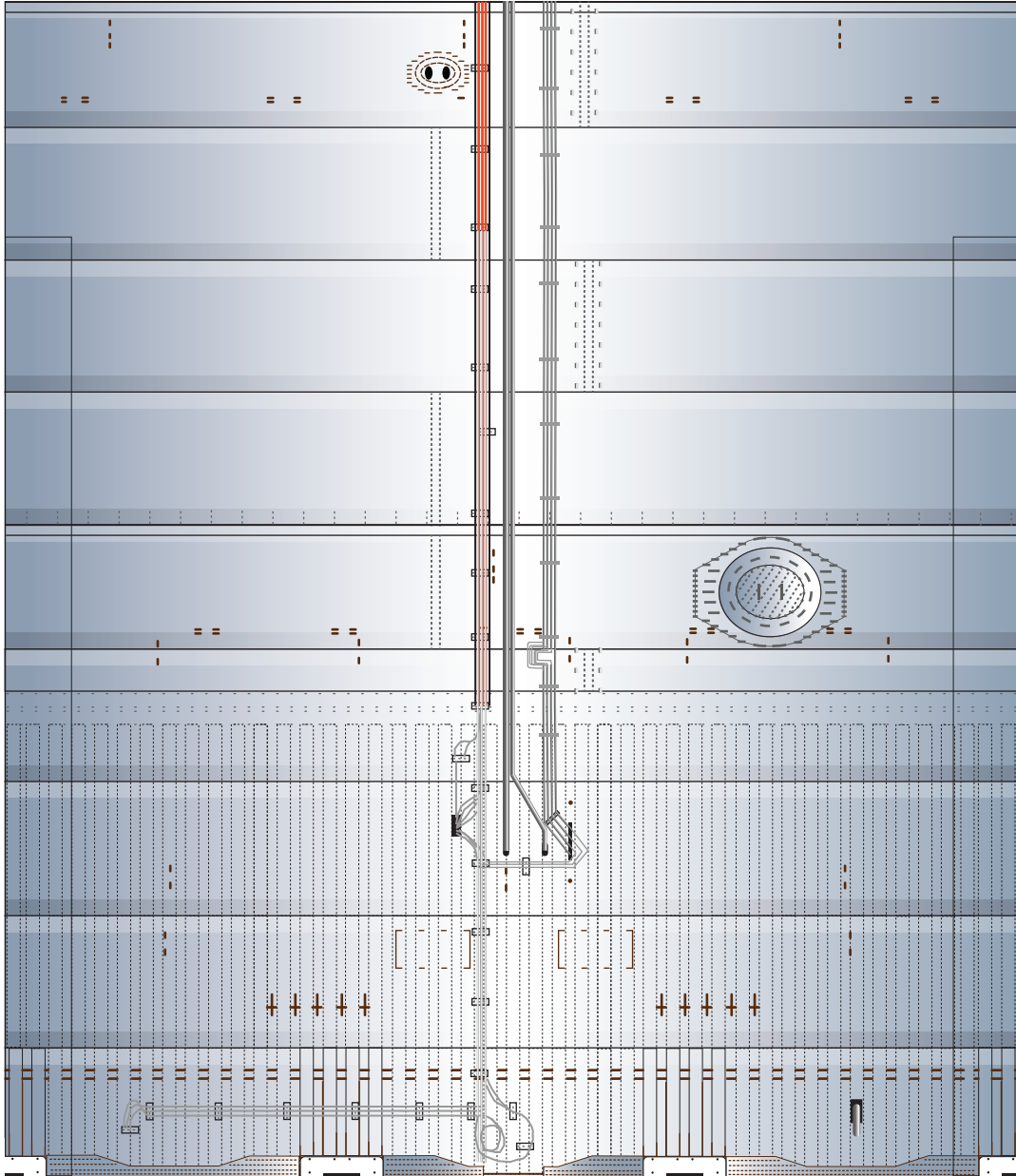
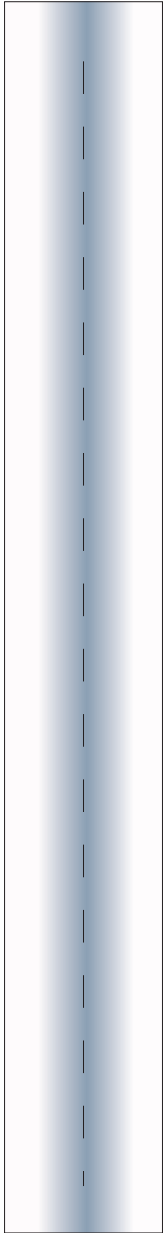



1:100 Scale



SpaceX Starship SN

Print on Cardstock (110 lbs)

Revised

Connectors for
nosecone

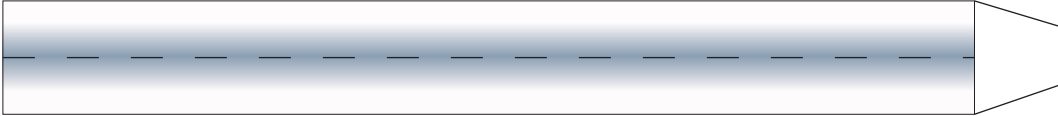
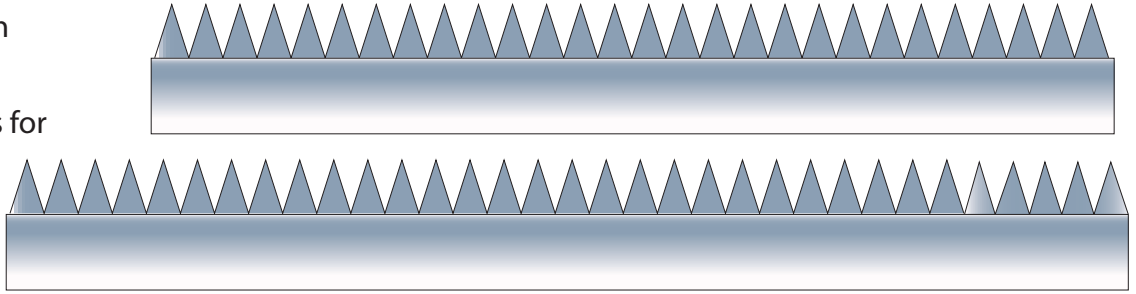

Connectors for upper
and lower body

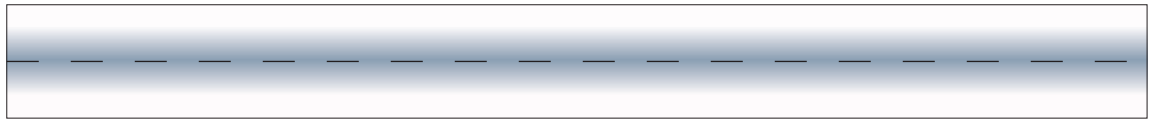

Engine section
interior wall

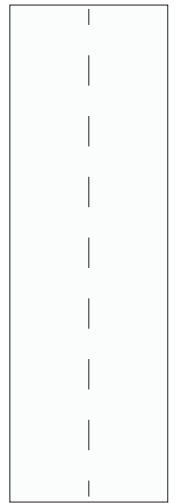
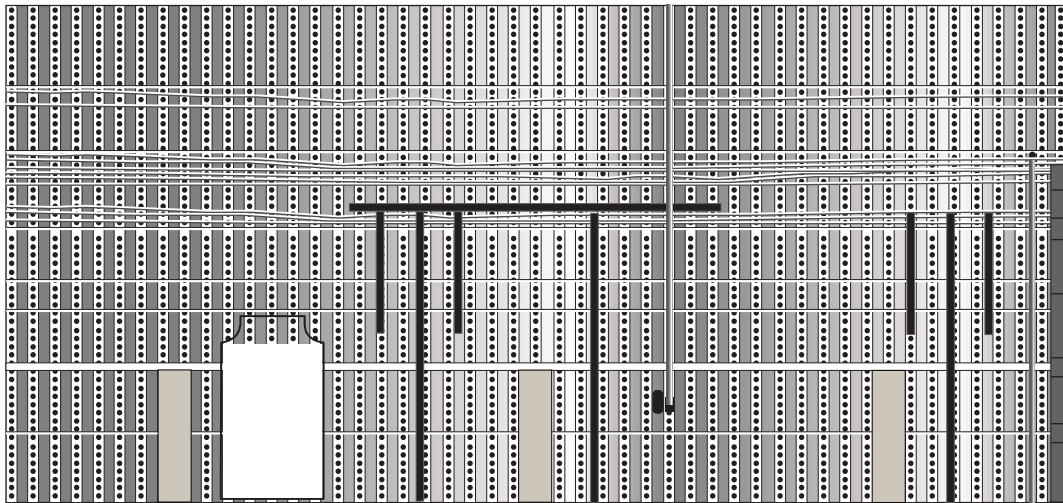
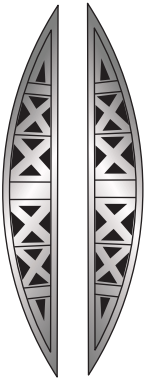

Curve this
segment

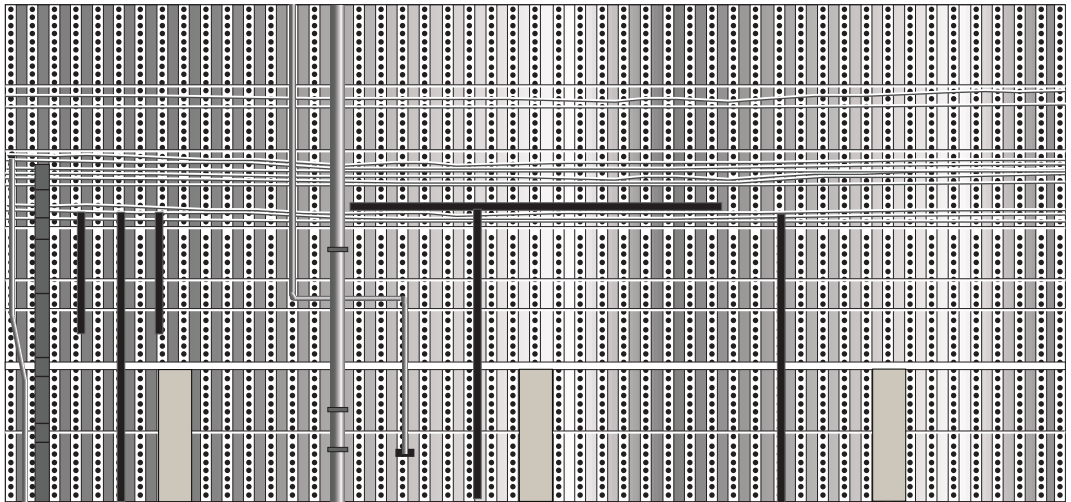
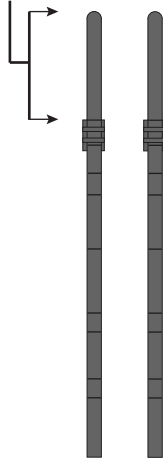
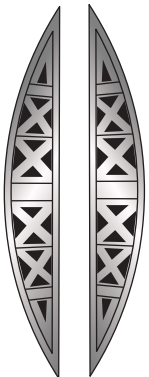



1:100 Scale

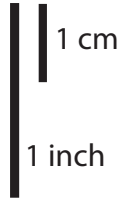

SpaceX Starship SN

Print on Cardstock (110 lbs)

Formers for lower body

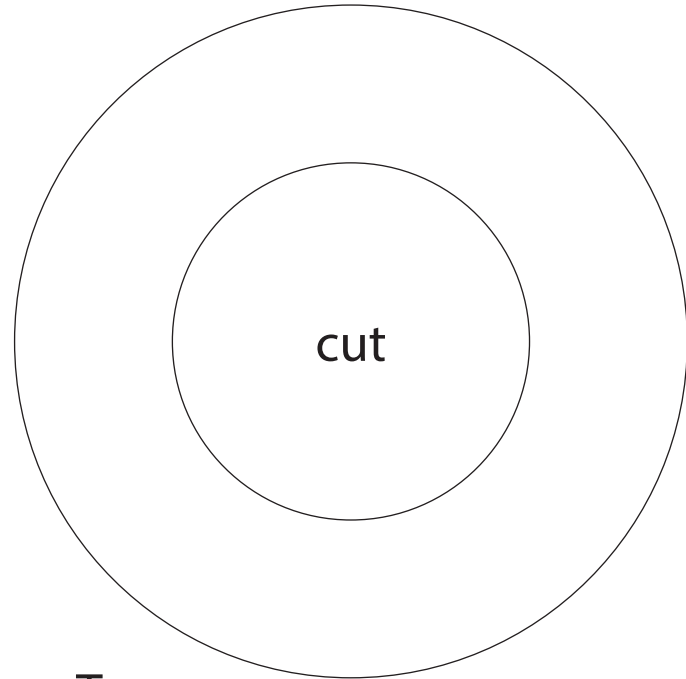

Top

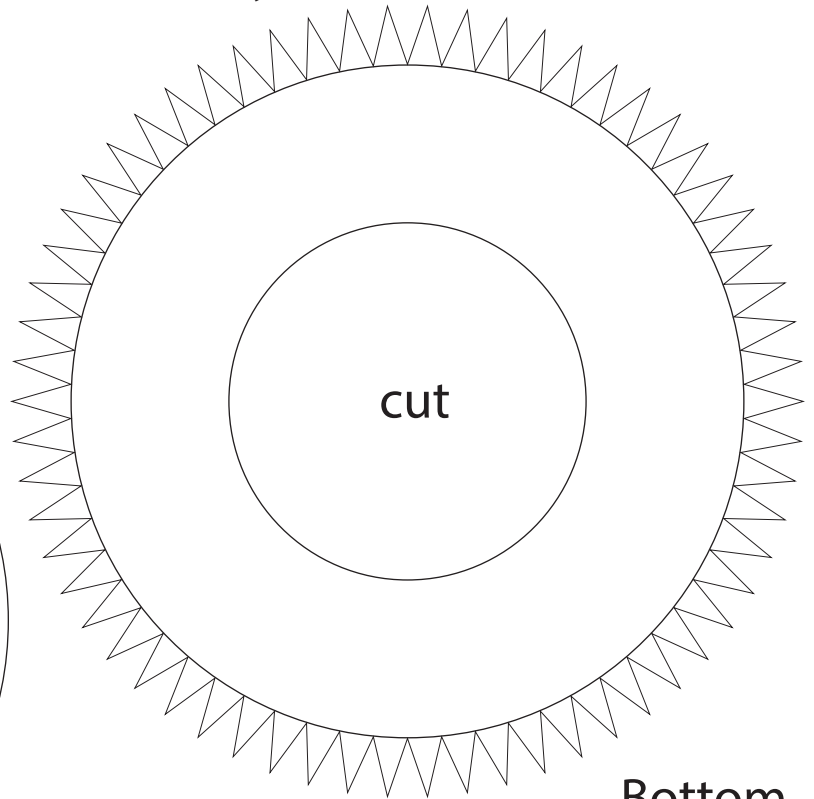

Bottom

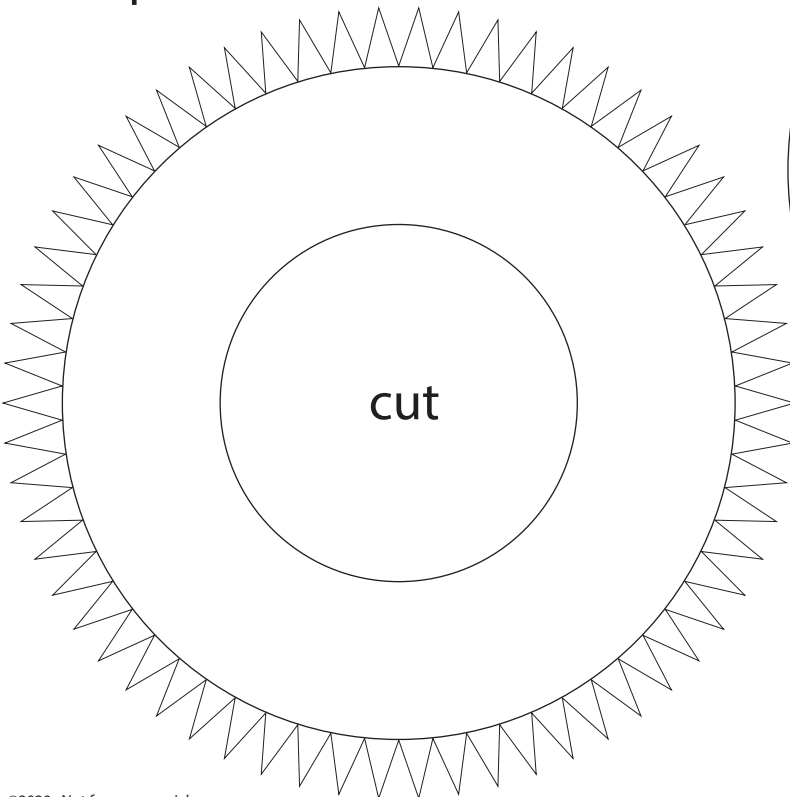

IMPORTANT
Top former is glued 20 mm from bottom edge of upper body.
Bottom former is glued 66 mm from bottom edge of lower body.



1 cm

1 inch

1:100 Scale

SpaceX Starship SN

Print on Cardstock (110 lbs)

Landing Legs

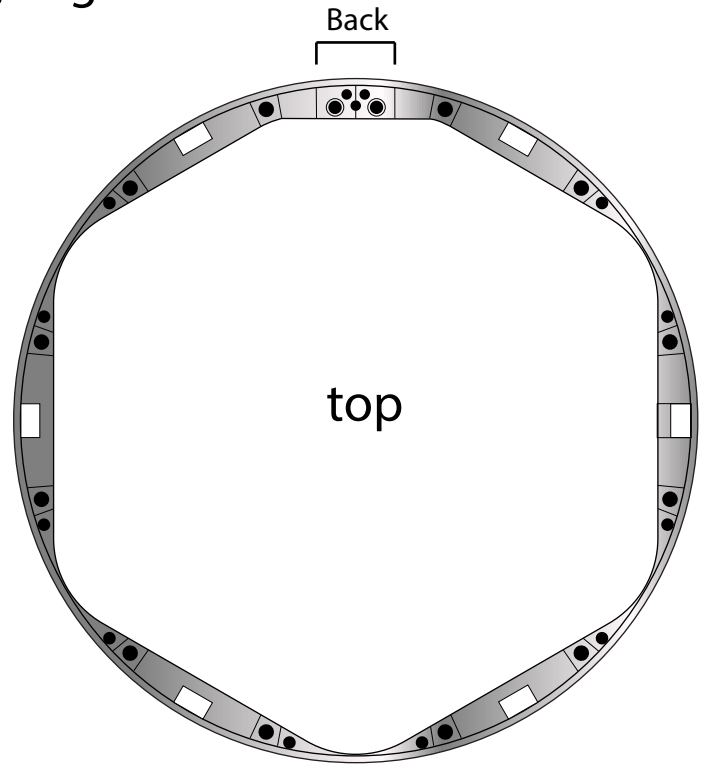
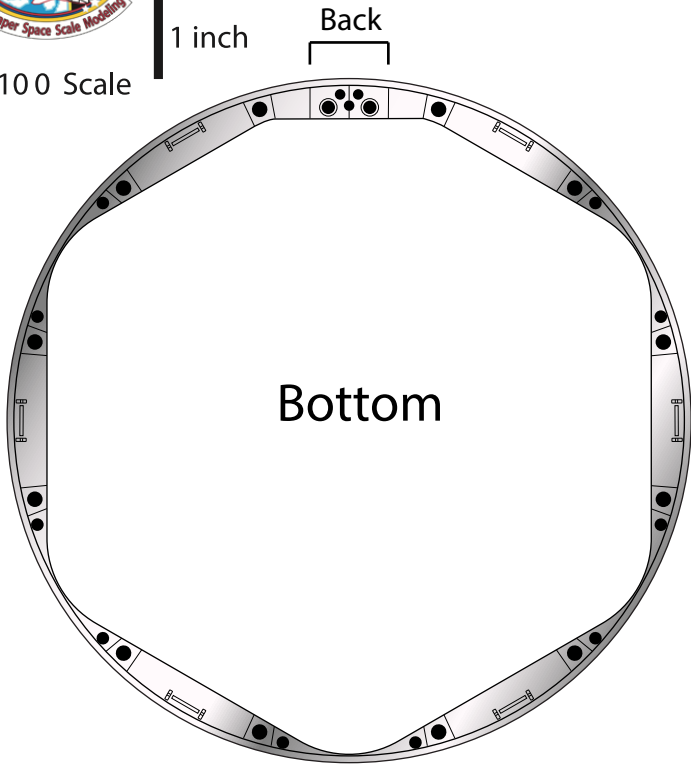

Leg support pillars

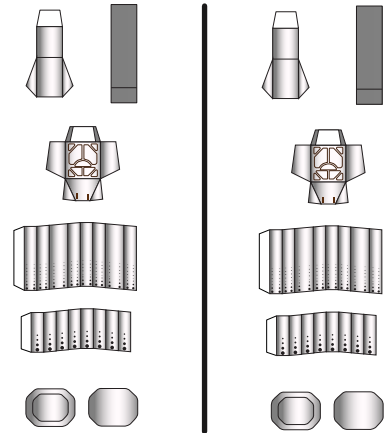
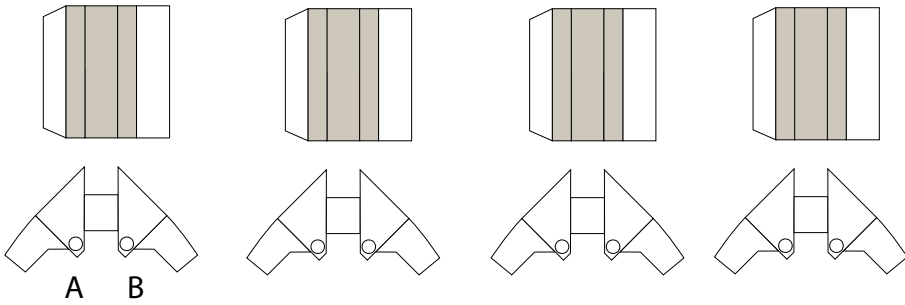

Landing Legs

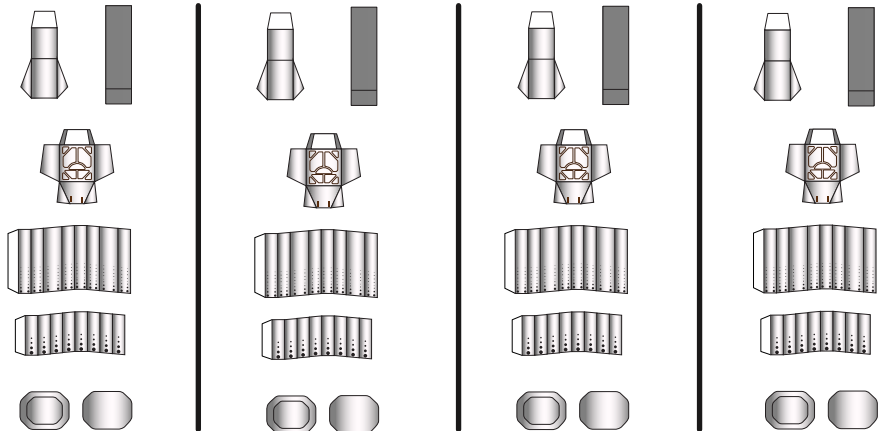
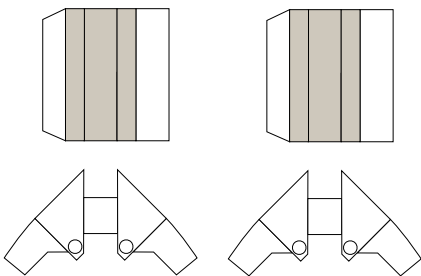

Use a cottonswab stick
(2 mm diameter) and cut 6
segments of 5 mm in length and
glue them between parts A and B.



1 cm
1 inch

SpaceX Starship SN

Print on Cardstock (110 lbs)

COPVs

1:100 Scale

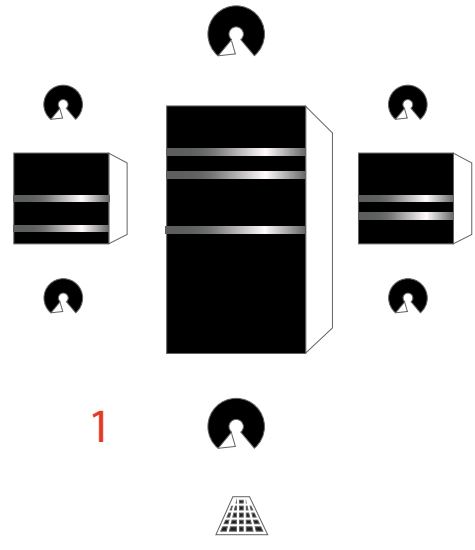

1

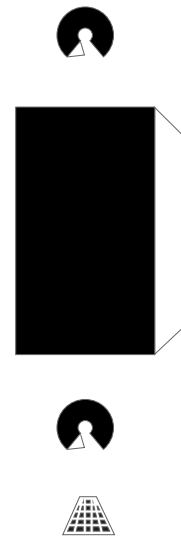

2

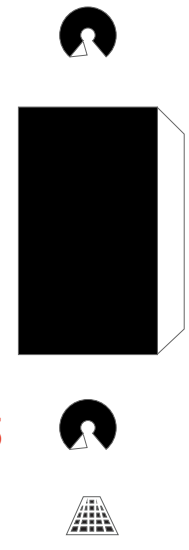

5

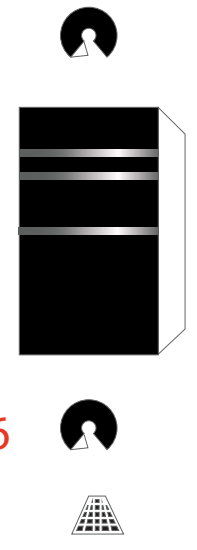

6

Tesla Battery #2

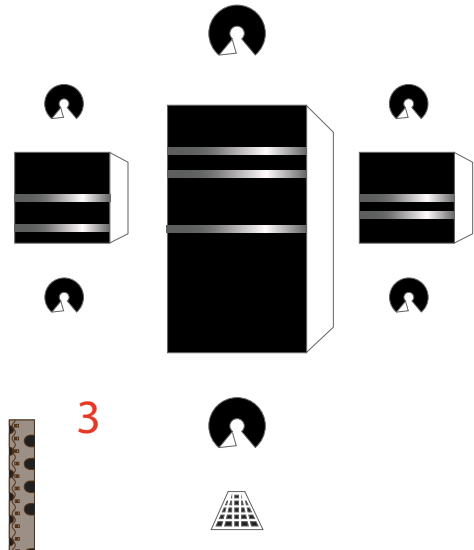
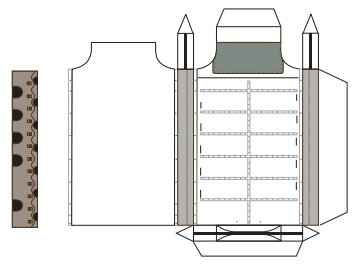

3

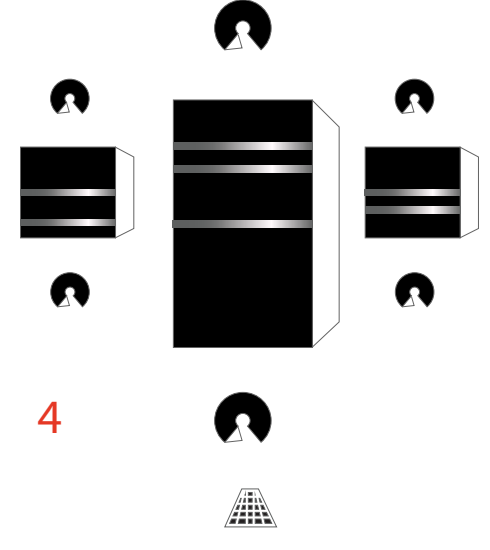

4

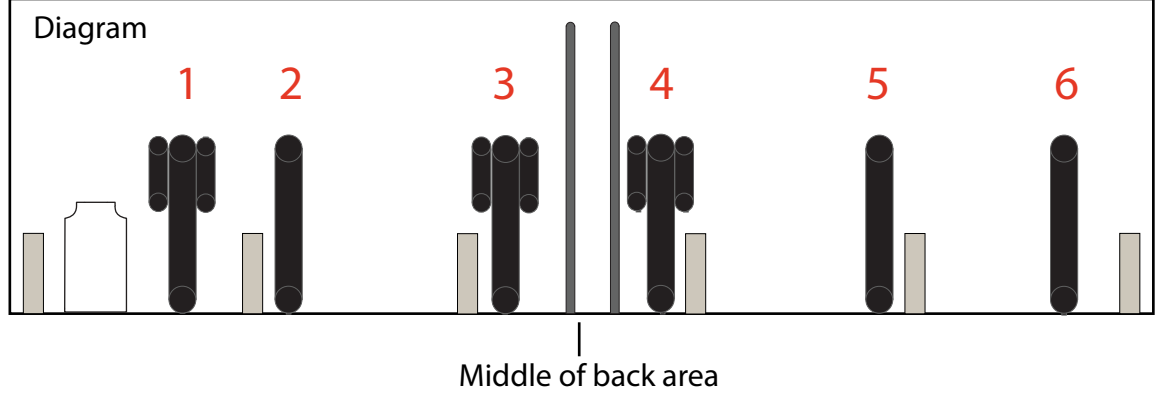

Use aluminum foil to cover all COPVs and Tesla battery.



1 cm

1 inch

1:100 Scale

Starship SN-9 Bulkhead

Print on Cardstock (110 lbs)

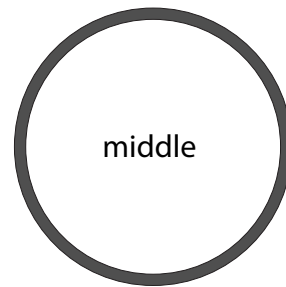
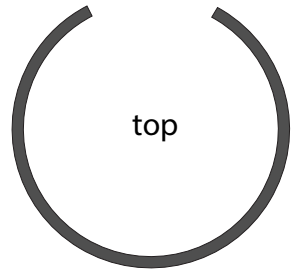
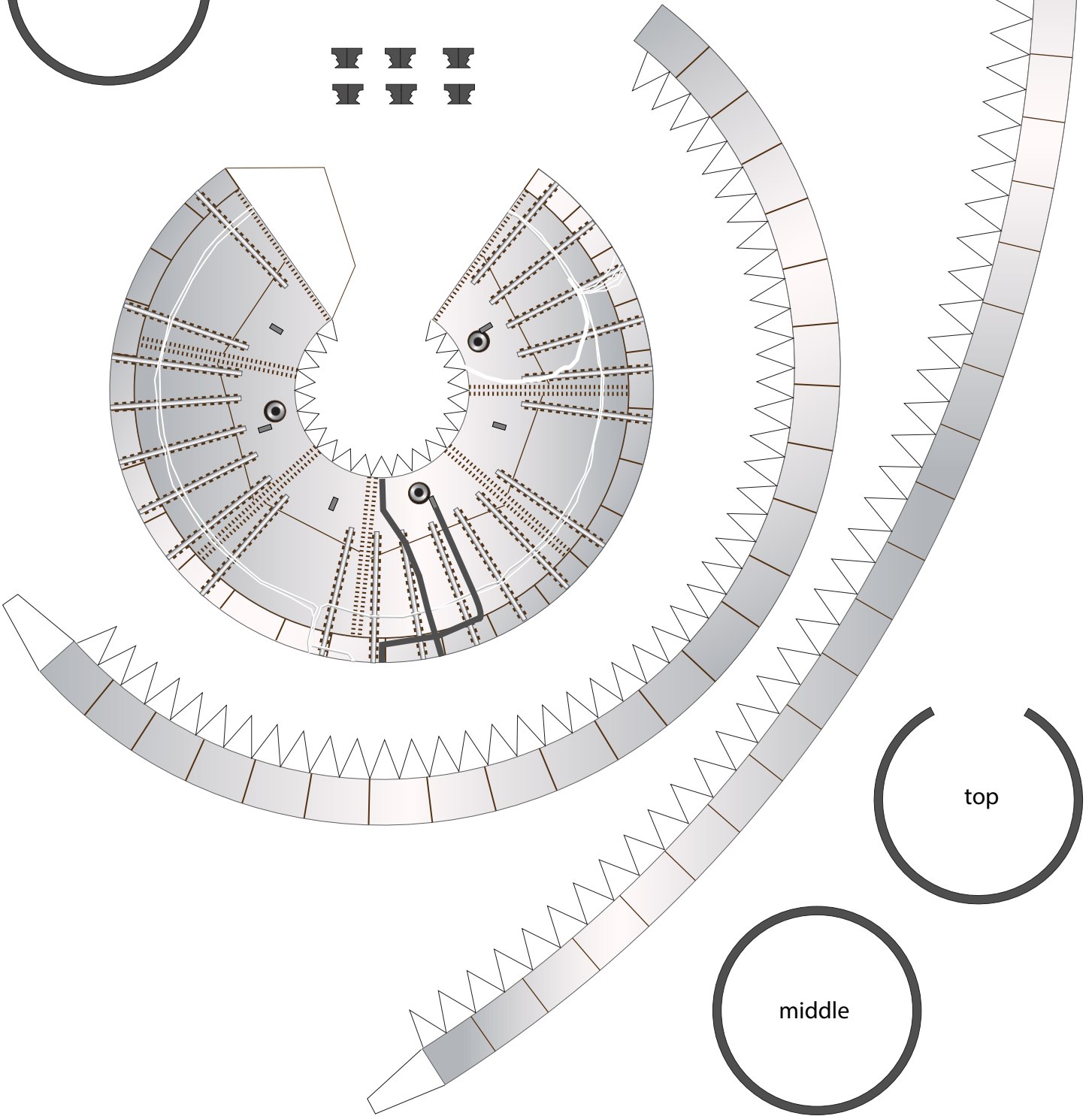
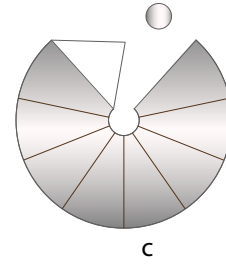
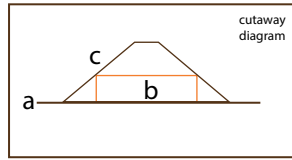
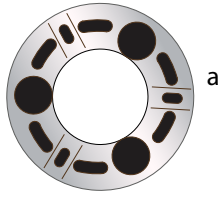
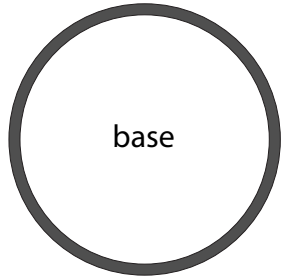



1 cm

1 inch

1:100 Scale

SpaceX Starship Raptors

Print on Cardstock (110 lbs)

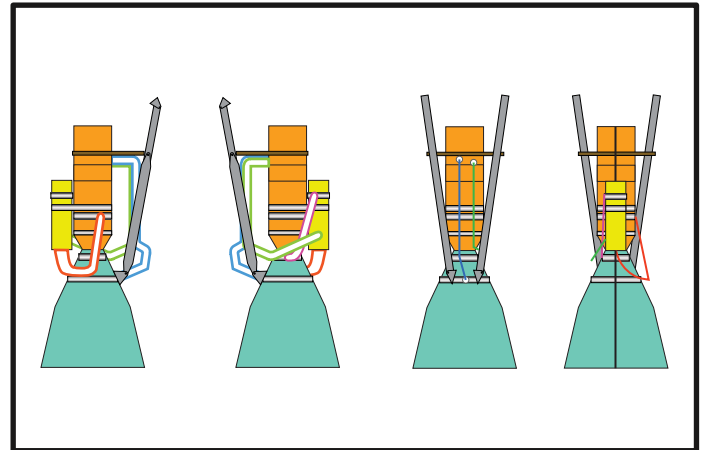
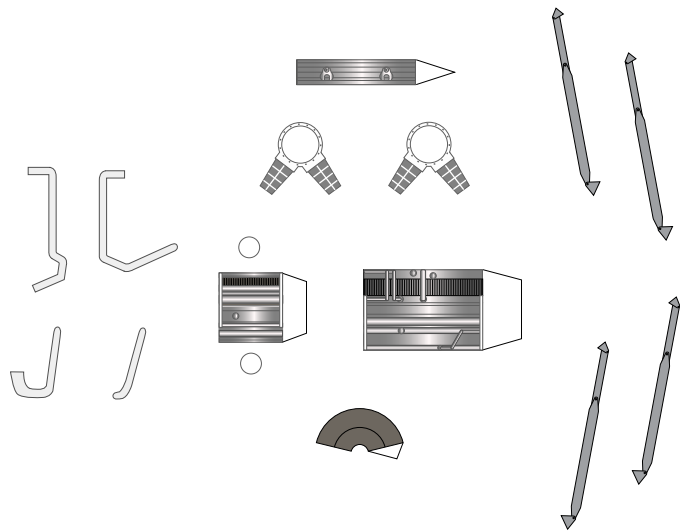
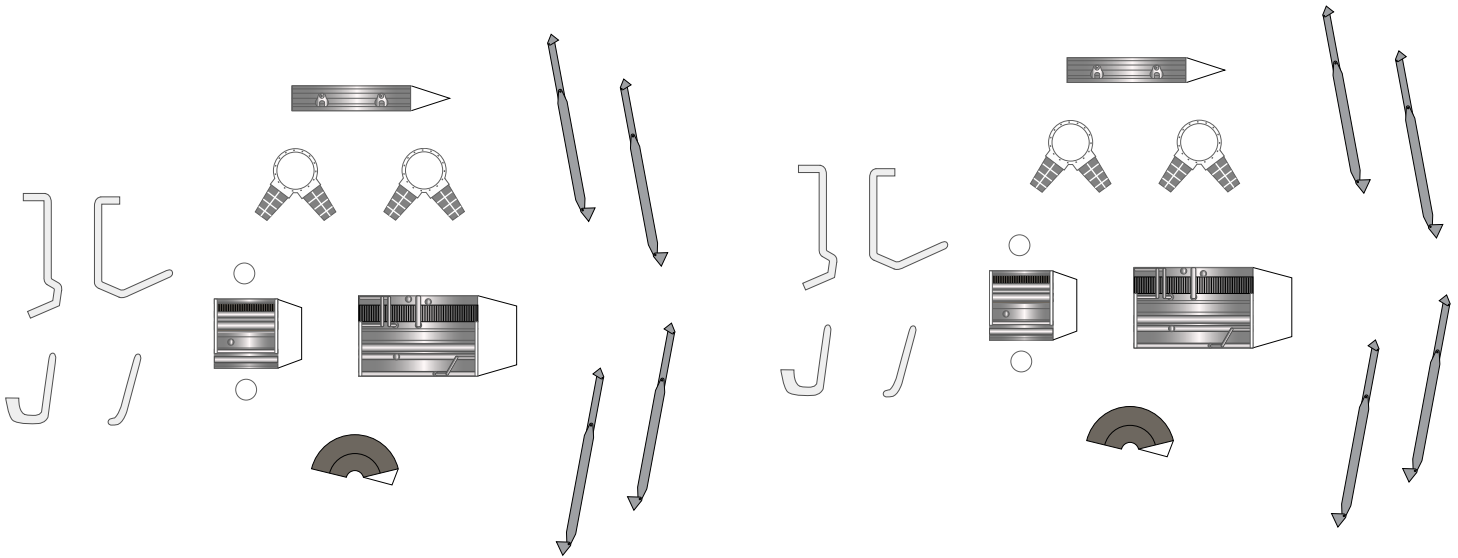
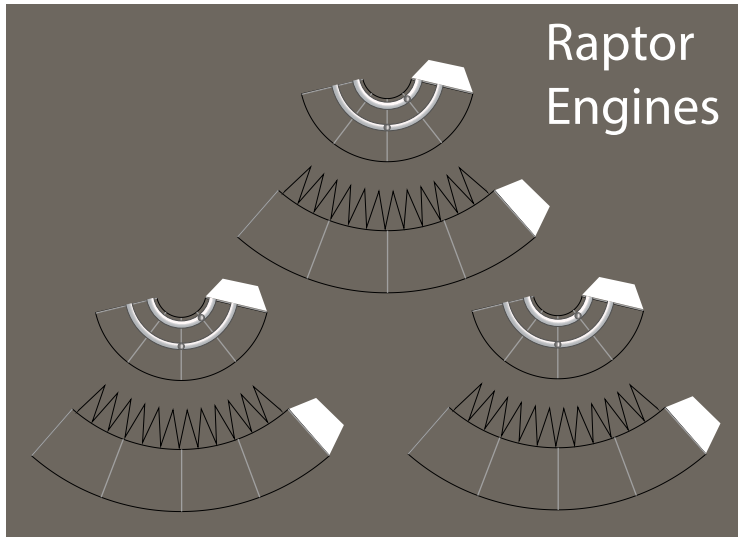





1:100 Scale

SpaceX Starship SN

Print on Cardstock (110 lbs)

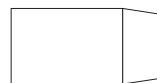
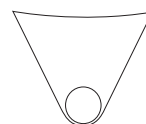
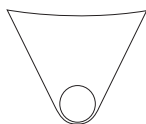
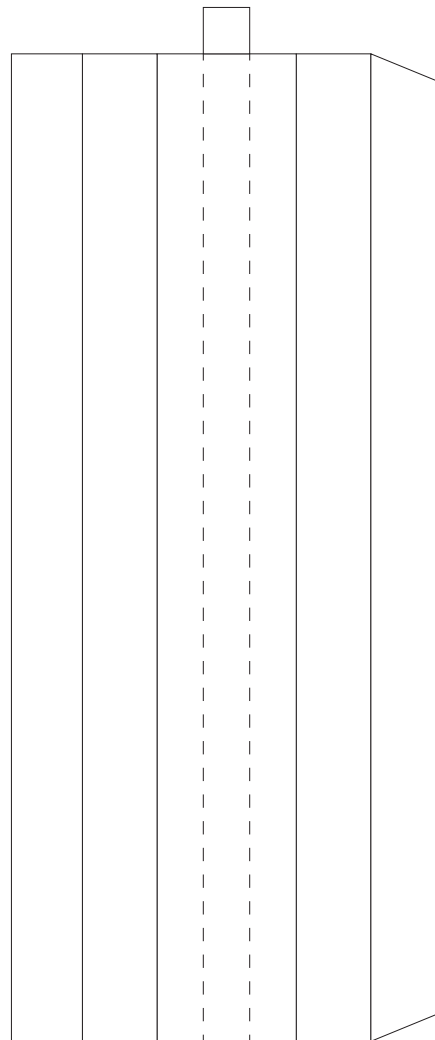
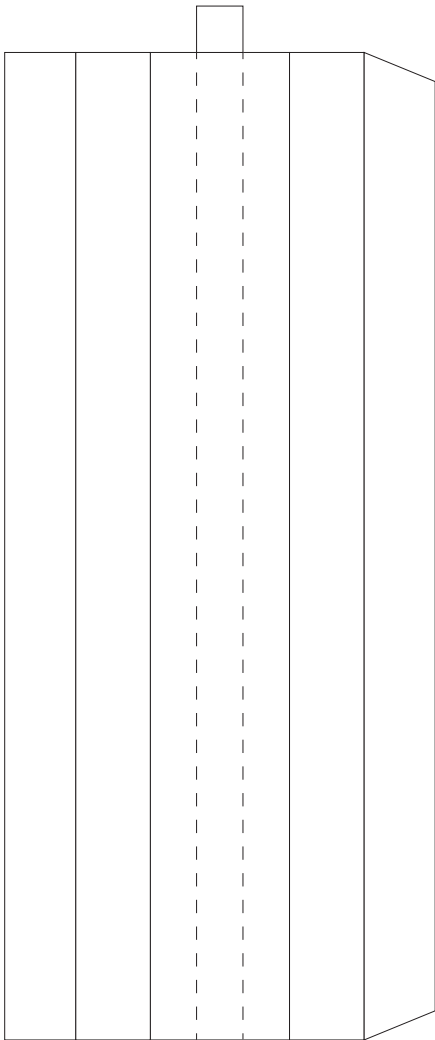
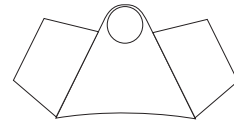
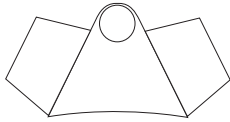
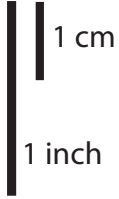



1:100 Scale

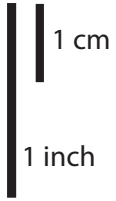

SpaceX Starship SN

Print on Cardstock (110 lbs)

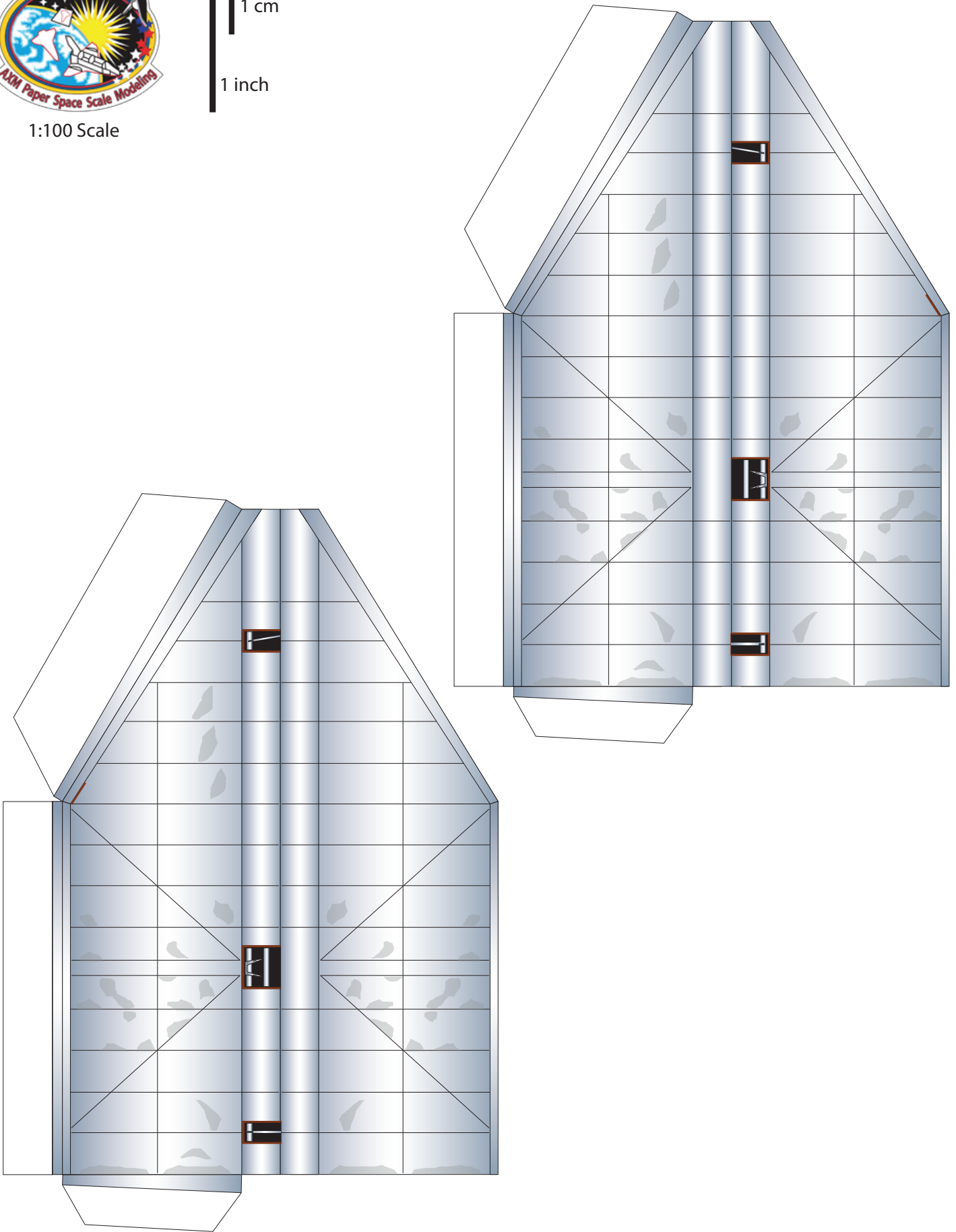



1:100 Scale

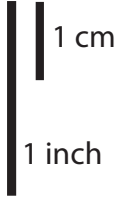

SpaceX Starship SN

Print on Cardstock (110 lbs)

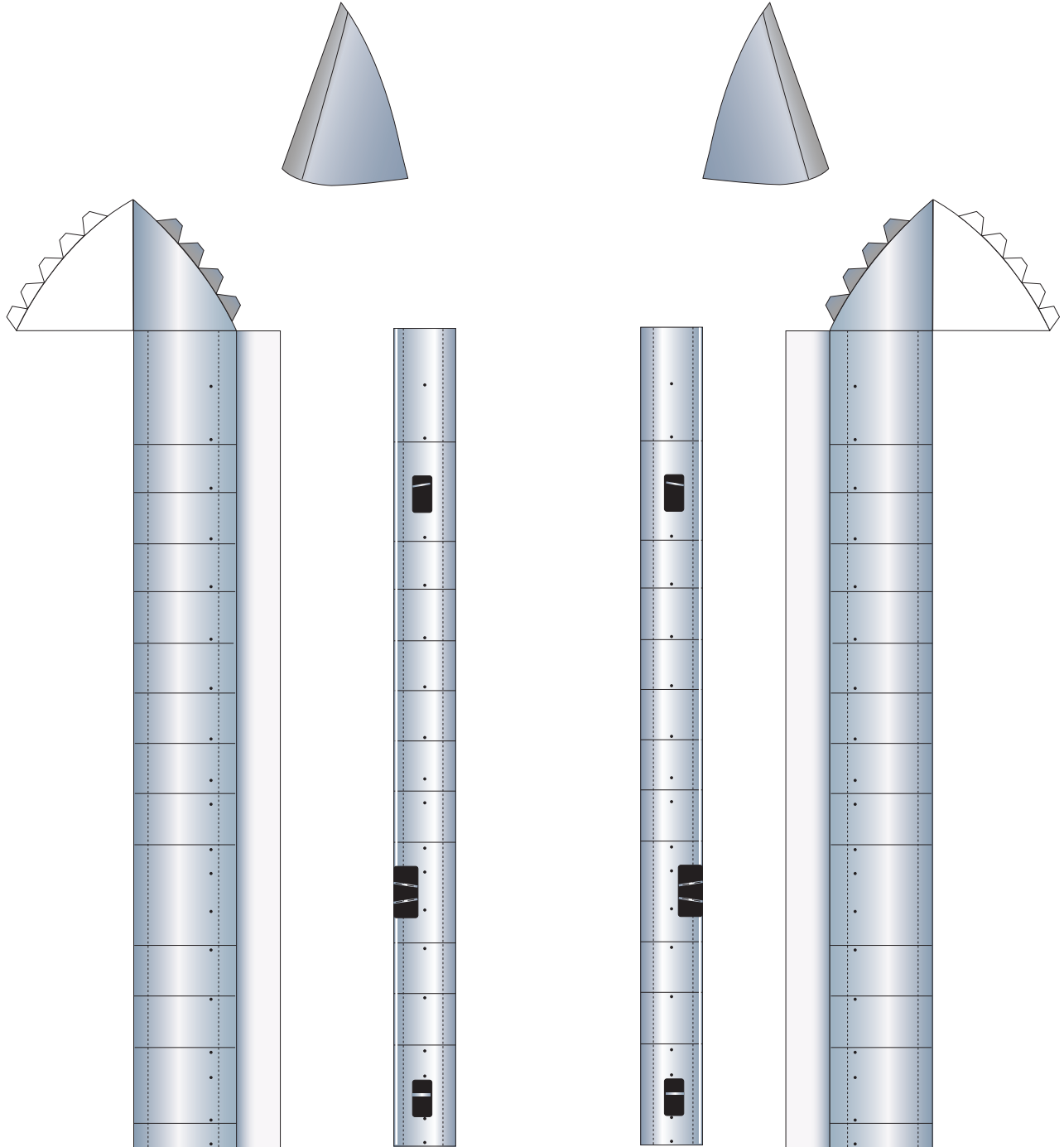



1:100 Scale

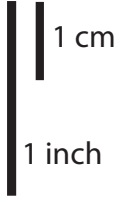

SpaceX Starship SN

Print on Cardstock (110 lbs)

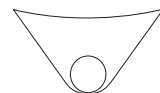
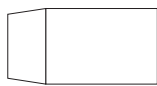
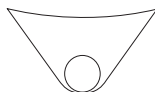
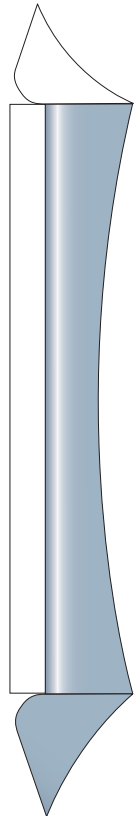
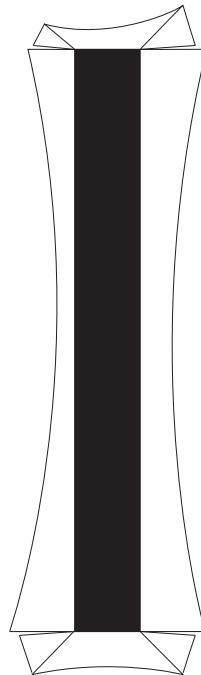
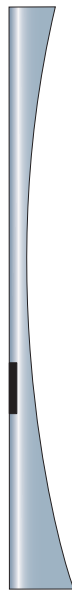
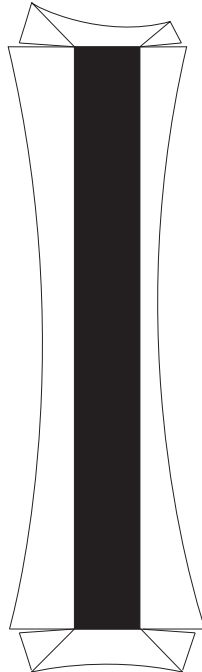
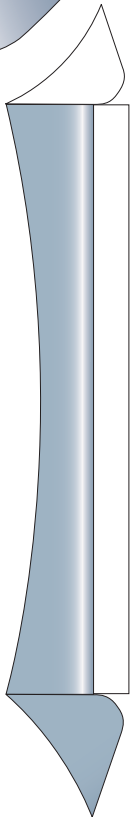
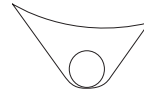
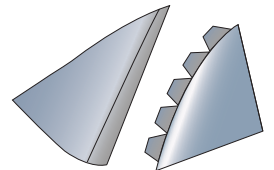
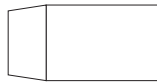
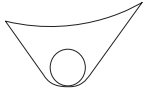
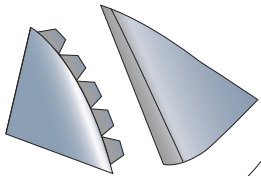
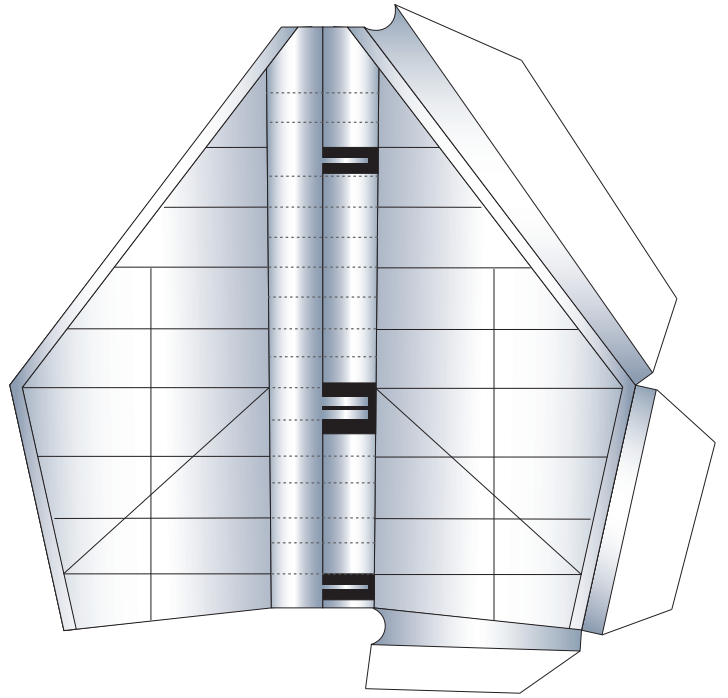
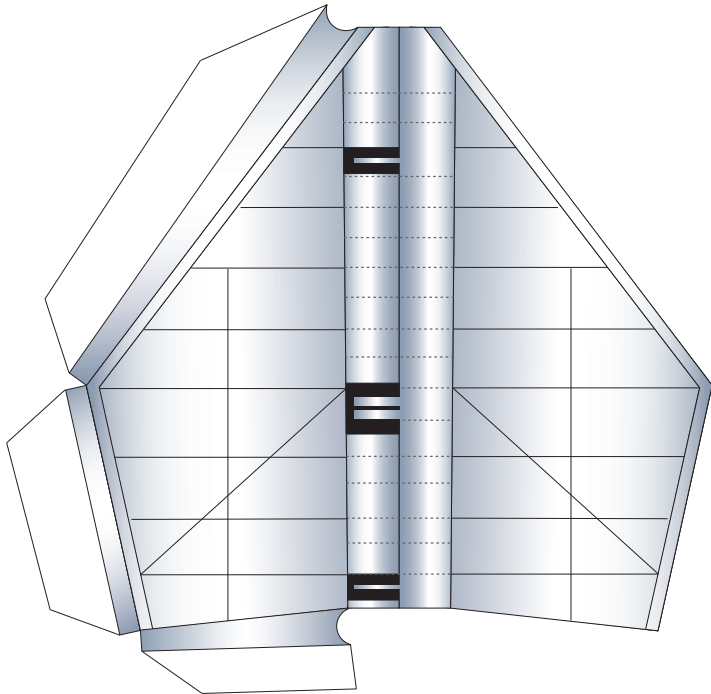



1 cm

1 inch

SpaceX Starship SN9

Print on Cardstock (110 lbs)

REFERENCE

NOT TO SCALE

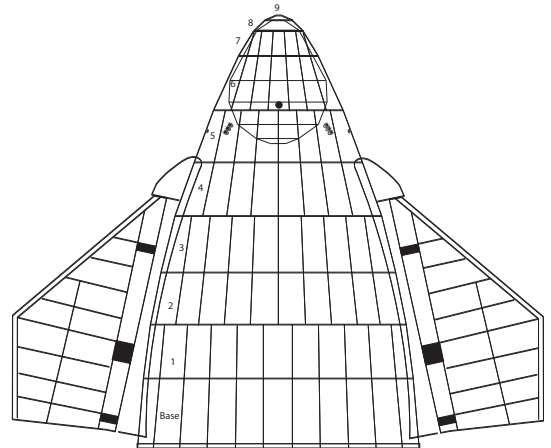
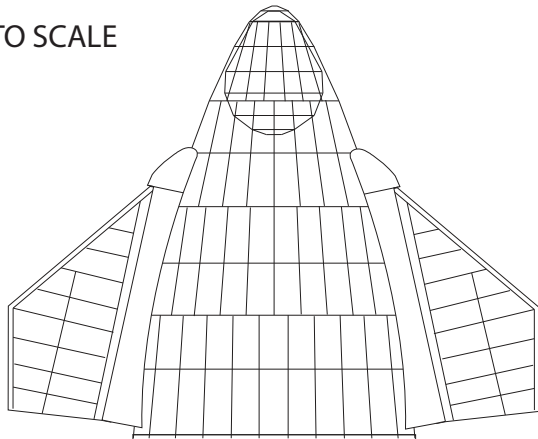

Umbilical side

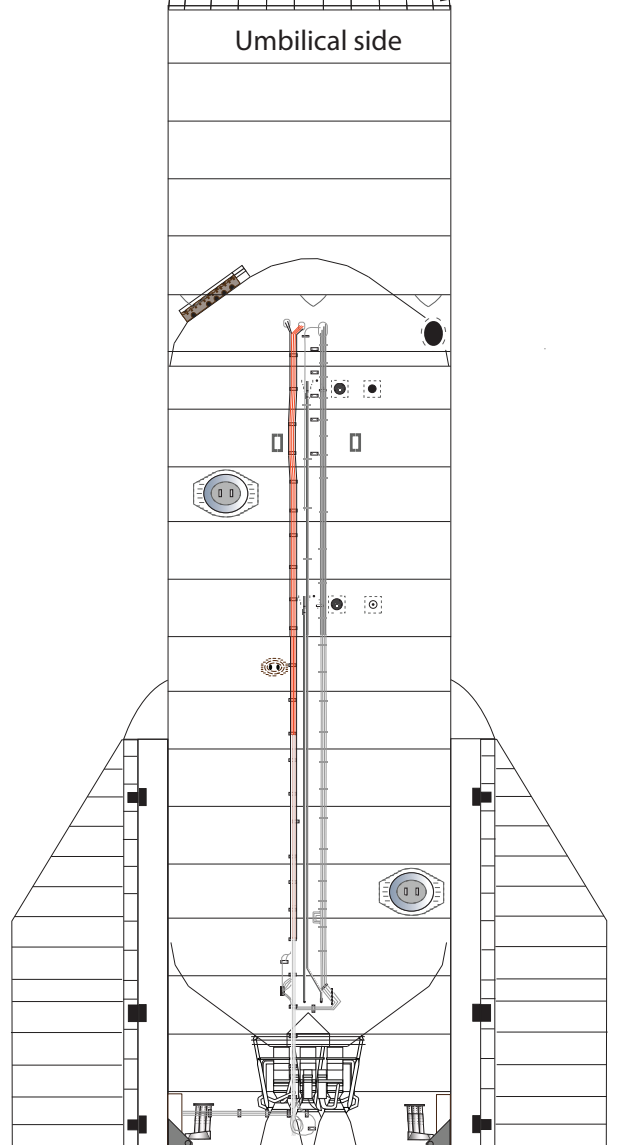
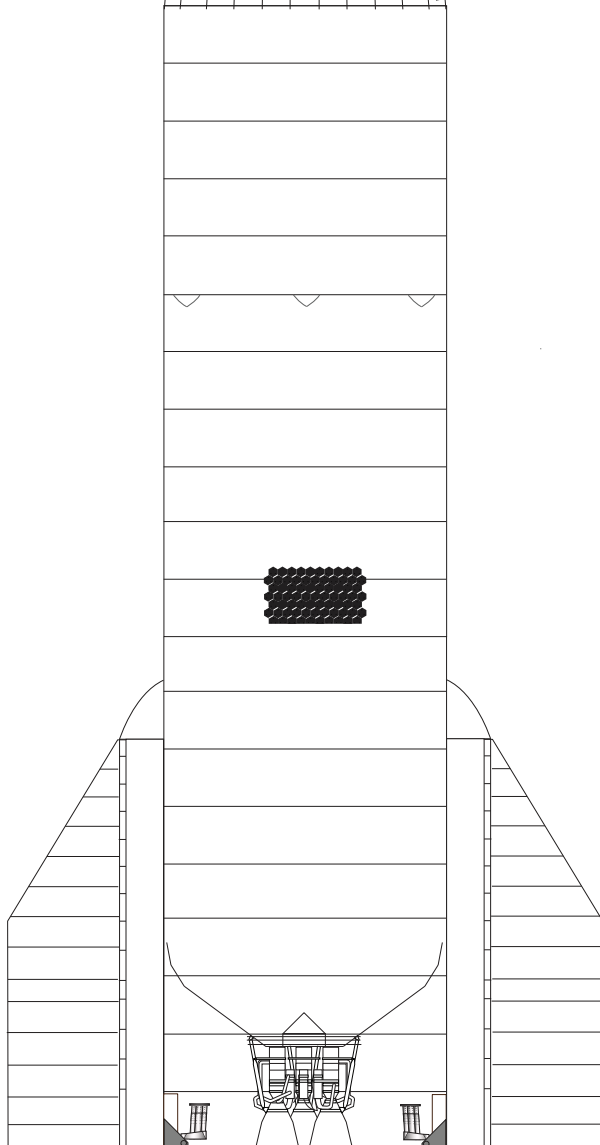

Front

Back



1:100 Scale



SpaceX Starship SN

(Optional)

Print on Cardstock (110 lbs)

Header Tank

Nosecone interior parts in red.

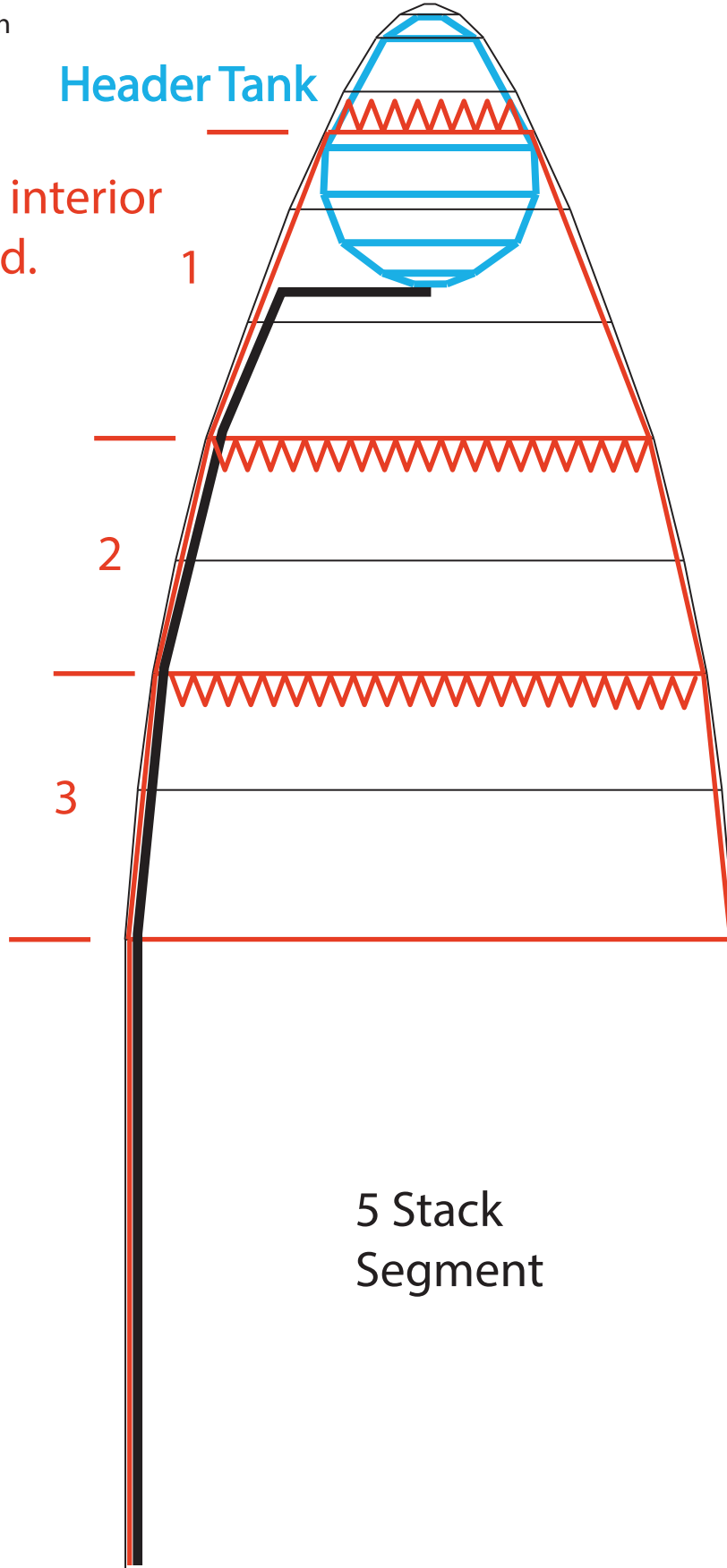

Header Tank pipe

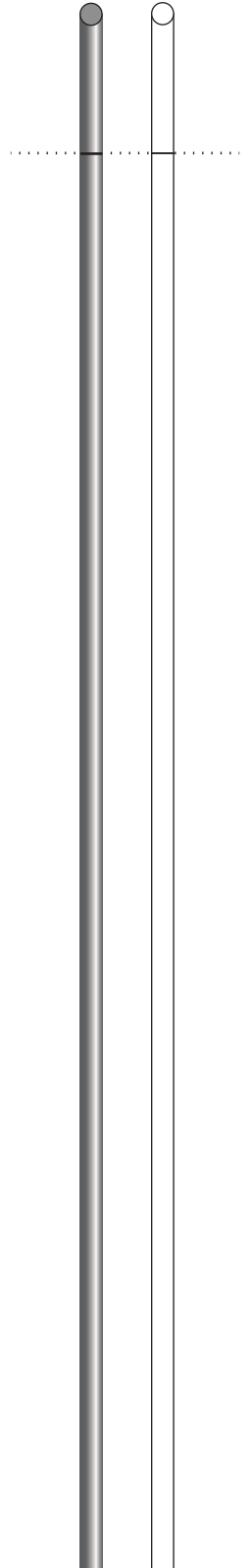

5 Stack Segment



1:100 Scale



SpaceX Starship SN Nosecone interior

Print on Cardstock (110 lbs)

(Optional)

Nosecone interior parts in red.

1

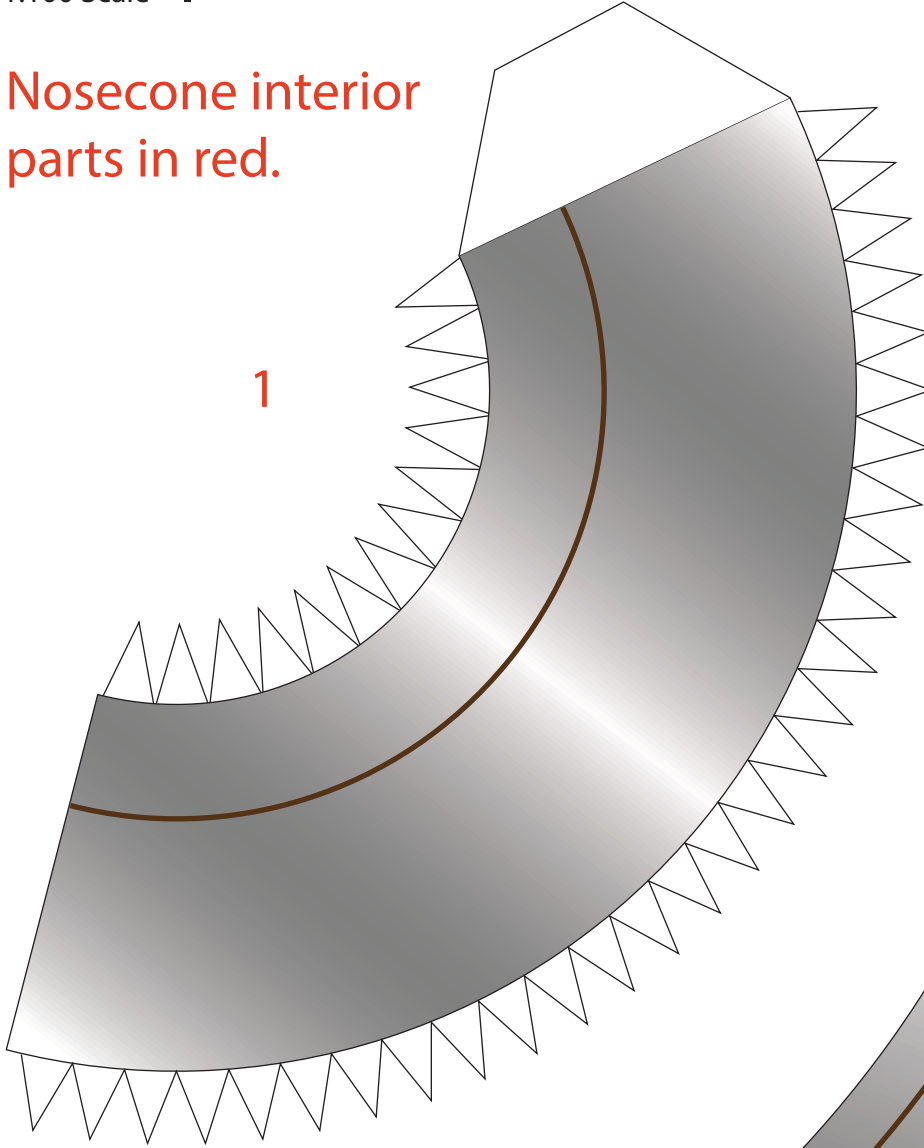

2

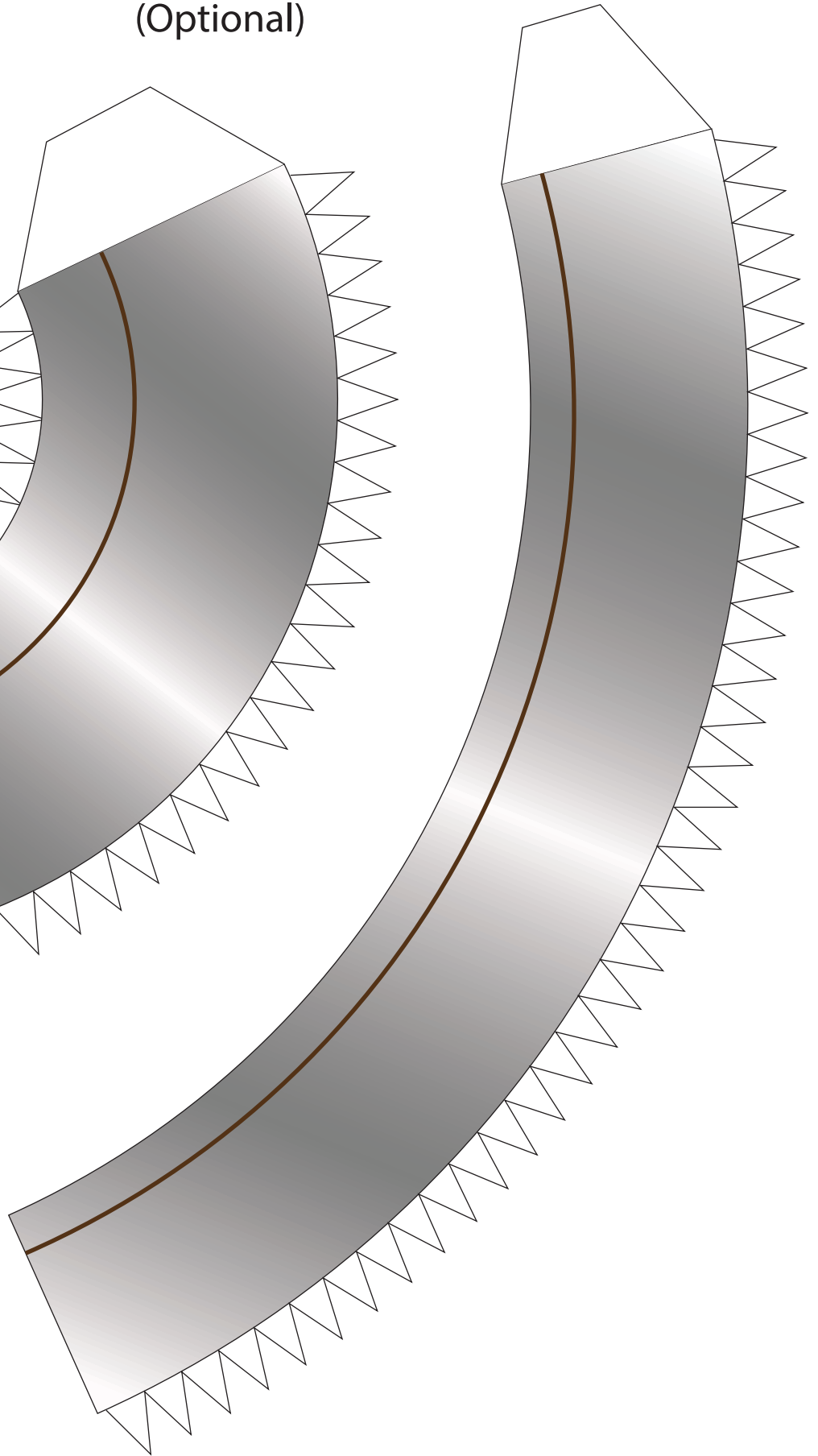



1:100 Scale



SpaceX Starship SN Header Tank

Print on Cardstock (110 lbs)

(Optional)

